

75274 TIE Fighter Pilot Helmet LED lighting Kit (Voice Control Version) LG65

Instructions for installing this kit:



All parts and components used in the manual are samples, and the pictures may be different from the actual ones, and the installation will not be affected under normal circumstances. If there is a problem, please contact us in time.

Power supply mode: USB power cord (please bring your own power supply).

It can be energized through a USB battery box (please pay attention to the positive and negative poles of the battery), power bank, mobile phone charger or USB socket. The normal voltage is 3-5V.

USB connectors to connect devices

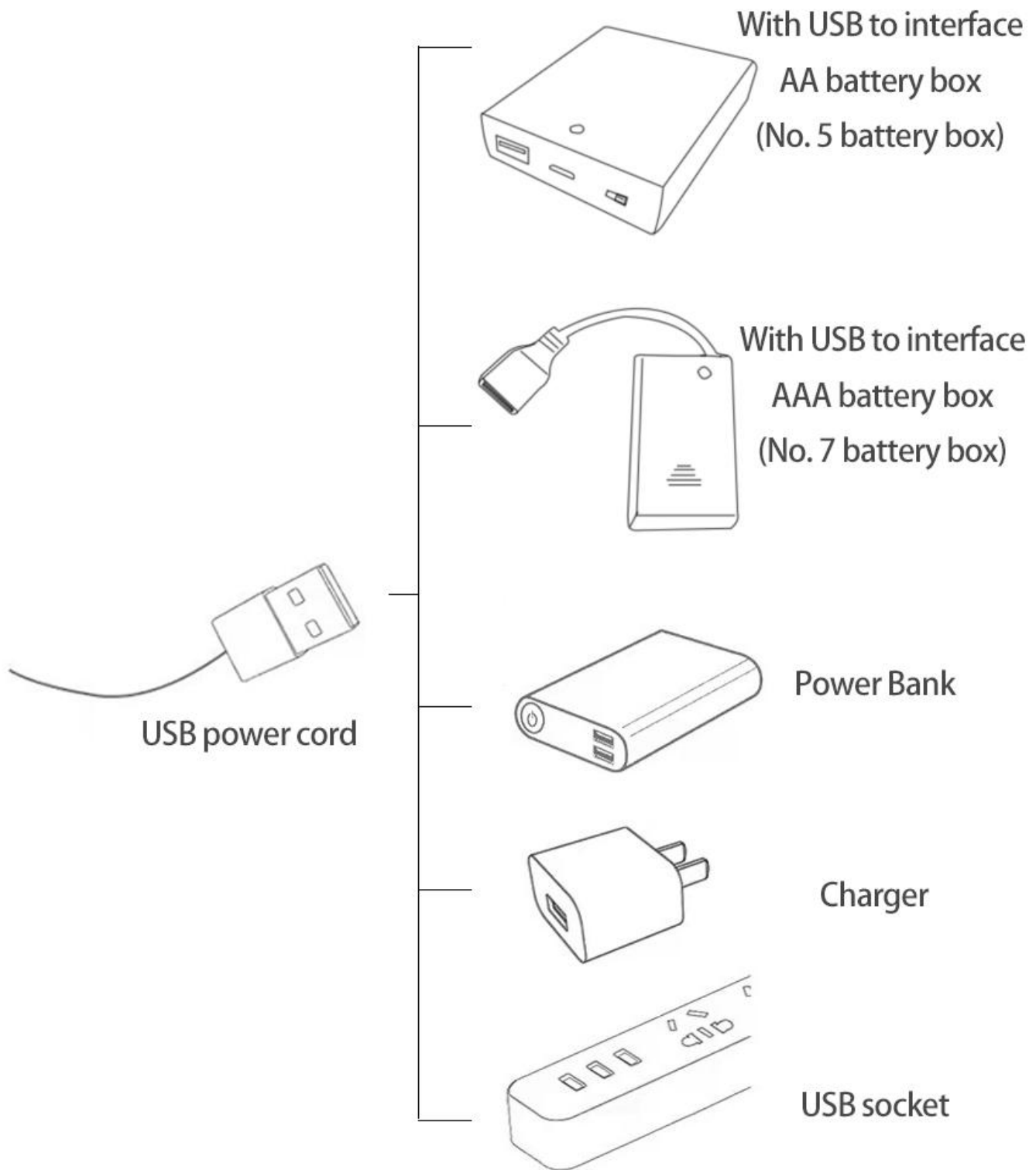

There are a total of 2 bags of this product, and Flat Battery Pack is a gift. (The battery is not provided in this product, please bring your own)



Open the bag from the place where the red line is drawn, don't tear it from the middle, so as not to damage the lighting



Lighting test:

Take out the accessories inside. The following power supply methods mainly use the battery box (please bring your own battery), and the USB power cord can be used by yourself.

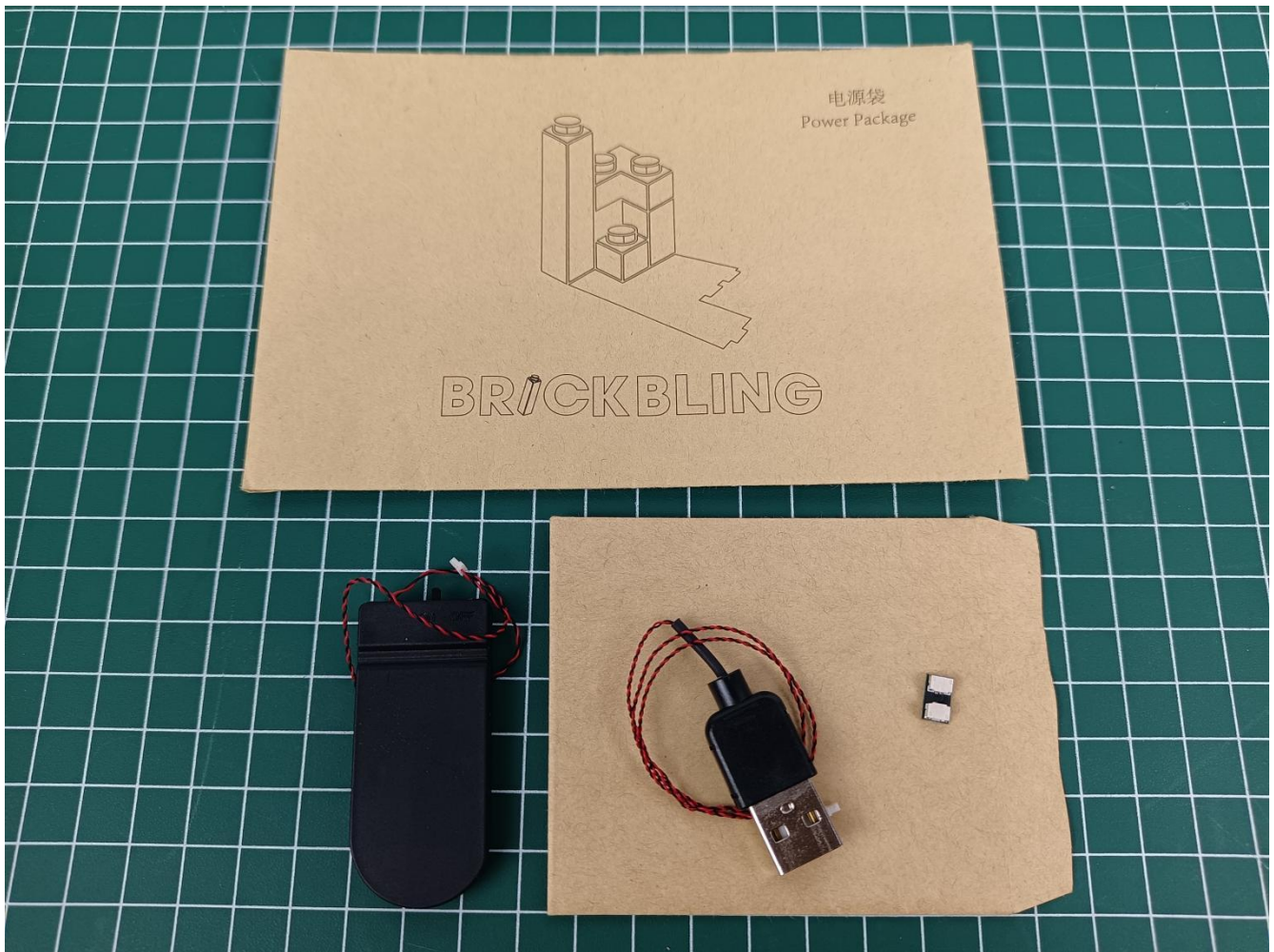

Take out the Flat Battery Pack and install the battery. (Pay attention to the positive and negative poles of the battery)

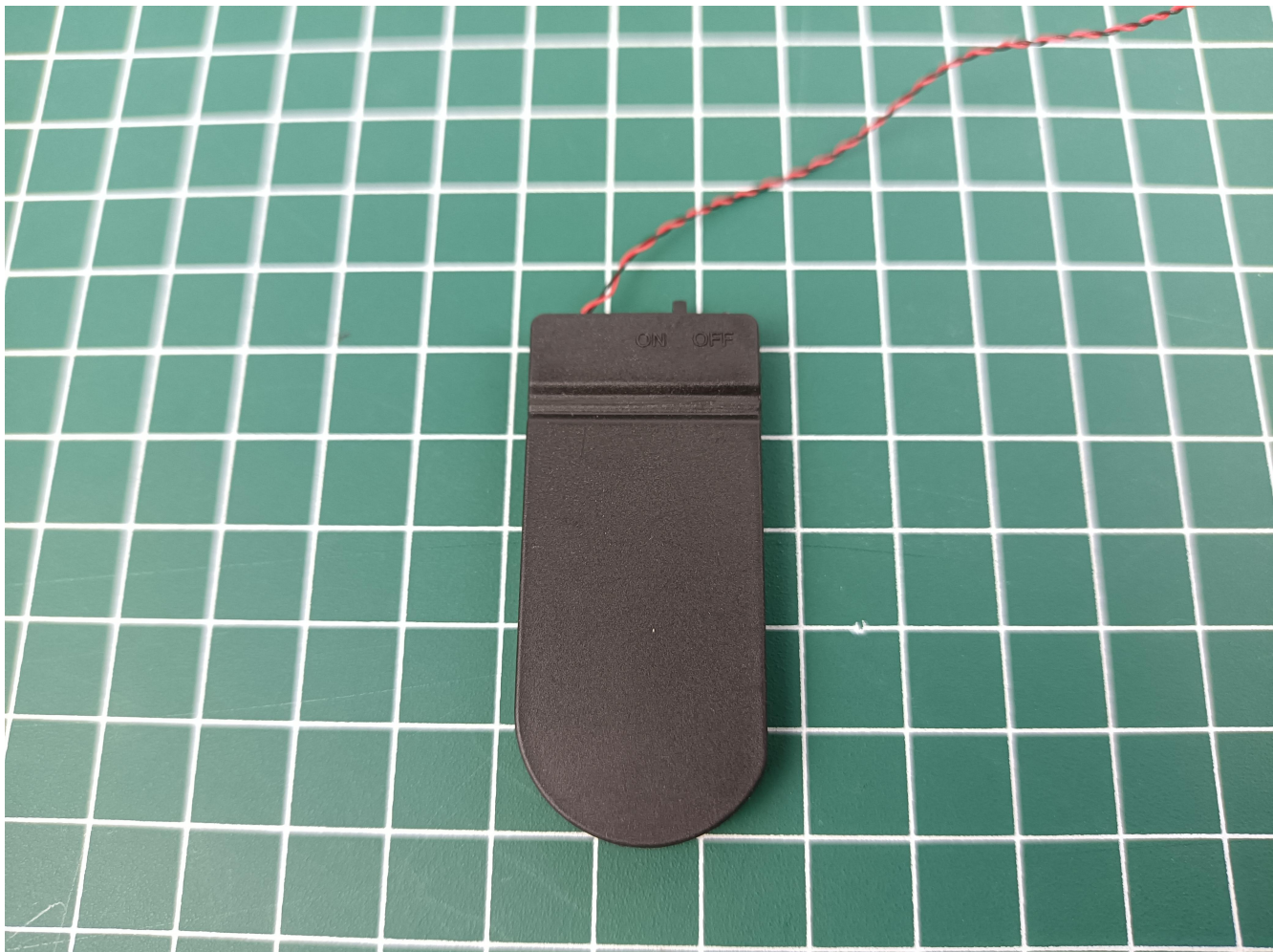

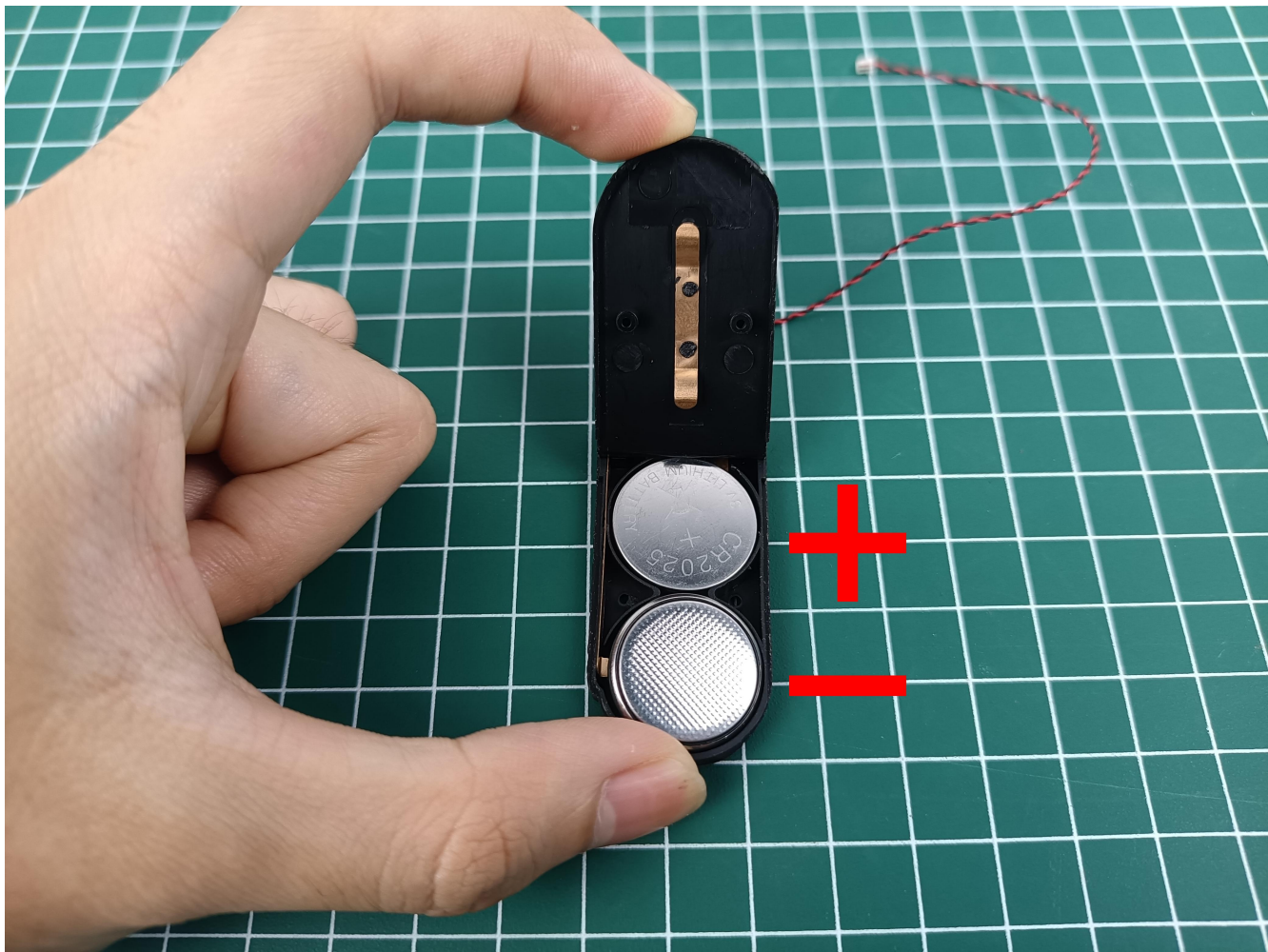

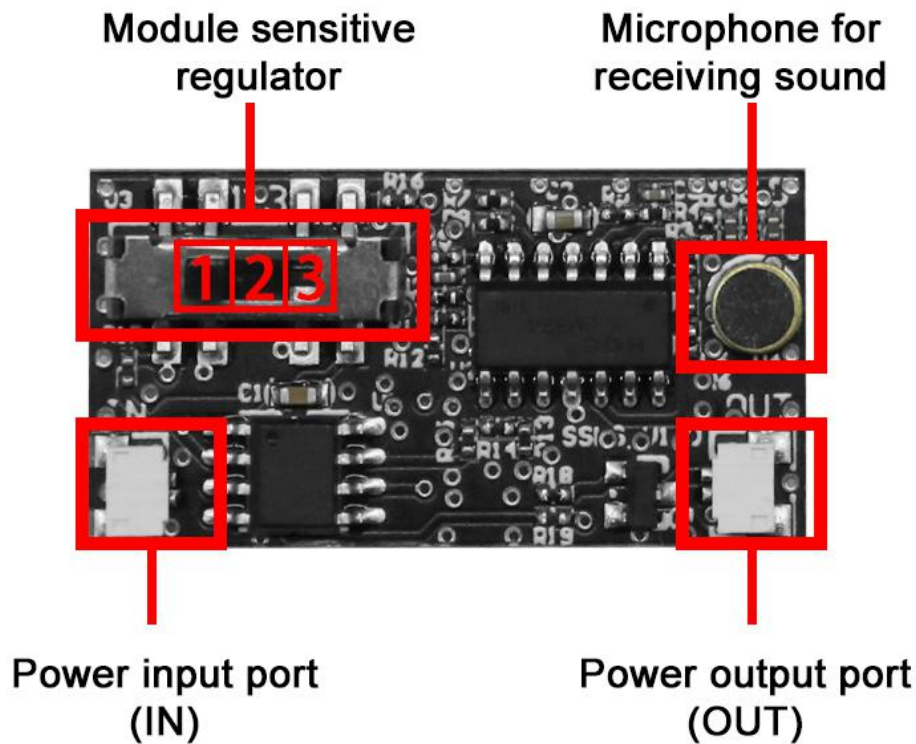

Module sensitivity adjuster. There are three gears, **1, 2, and 3**. The received decibels are **25dB, 50dB, 90dB**.

In a noisy environment, using the 1st gear, the lights will always be on and off. At this time, you need to increase the gear to 2 or 3 gears to work normally. In a quiet environment, Gear 3 will be difficult to trigger. It is recommended to use gear 1 or 2.

Before starting the installation, please test and select the position of the voice switch that suits your environment.

(Note: Because the voltage of the power bank often changes, the lighting on the module sometimes flickers. It is recommended to use a battery box or a stable mobile phone charger for power supply.)

Take out the Voice Control Module.

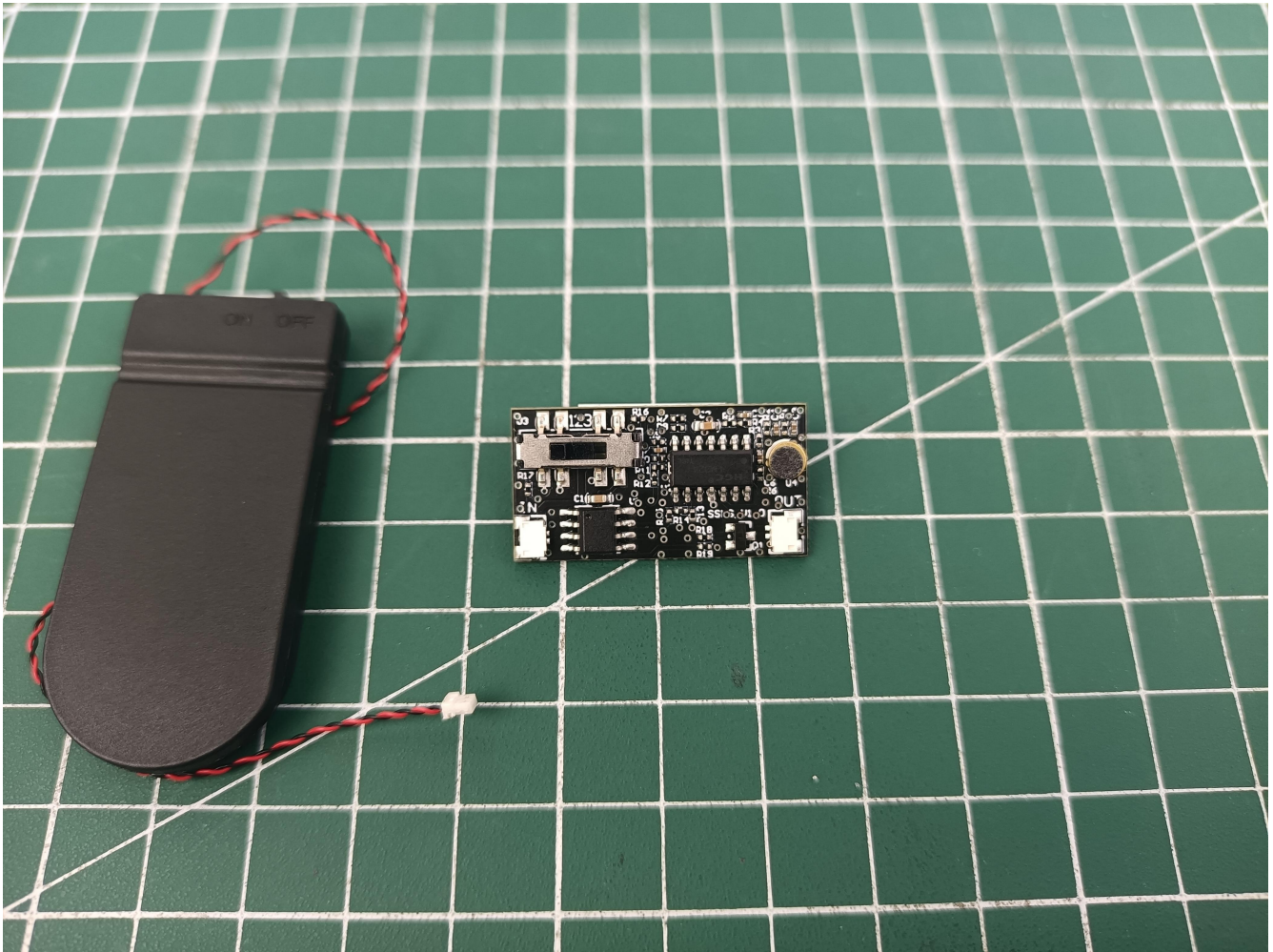

The two are connected through the interface, the connection method is as follows.

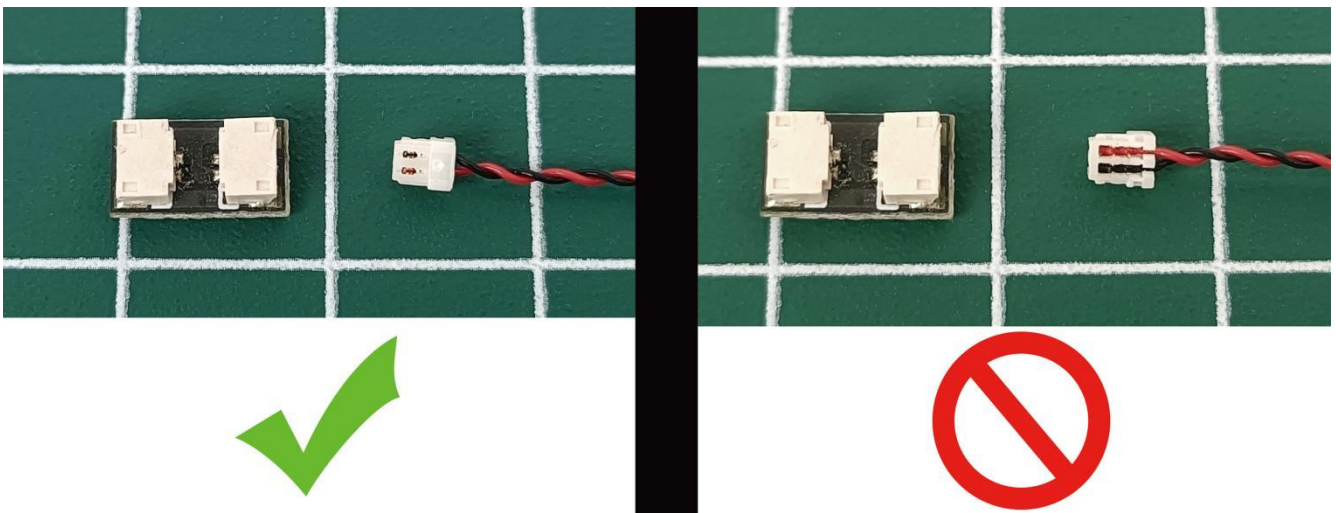

Connect the Flat Battery Pack to the voice control module.

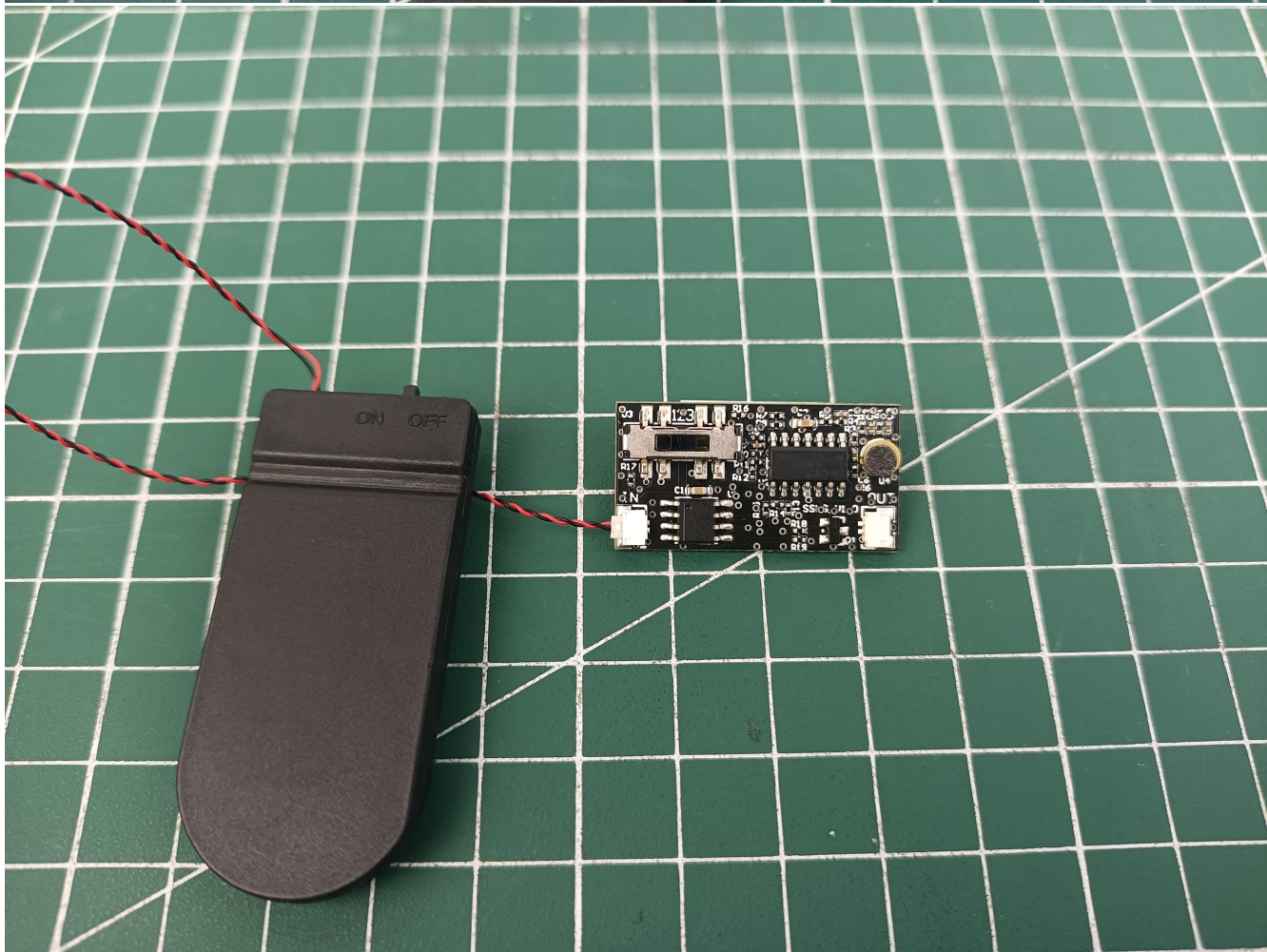
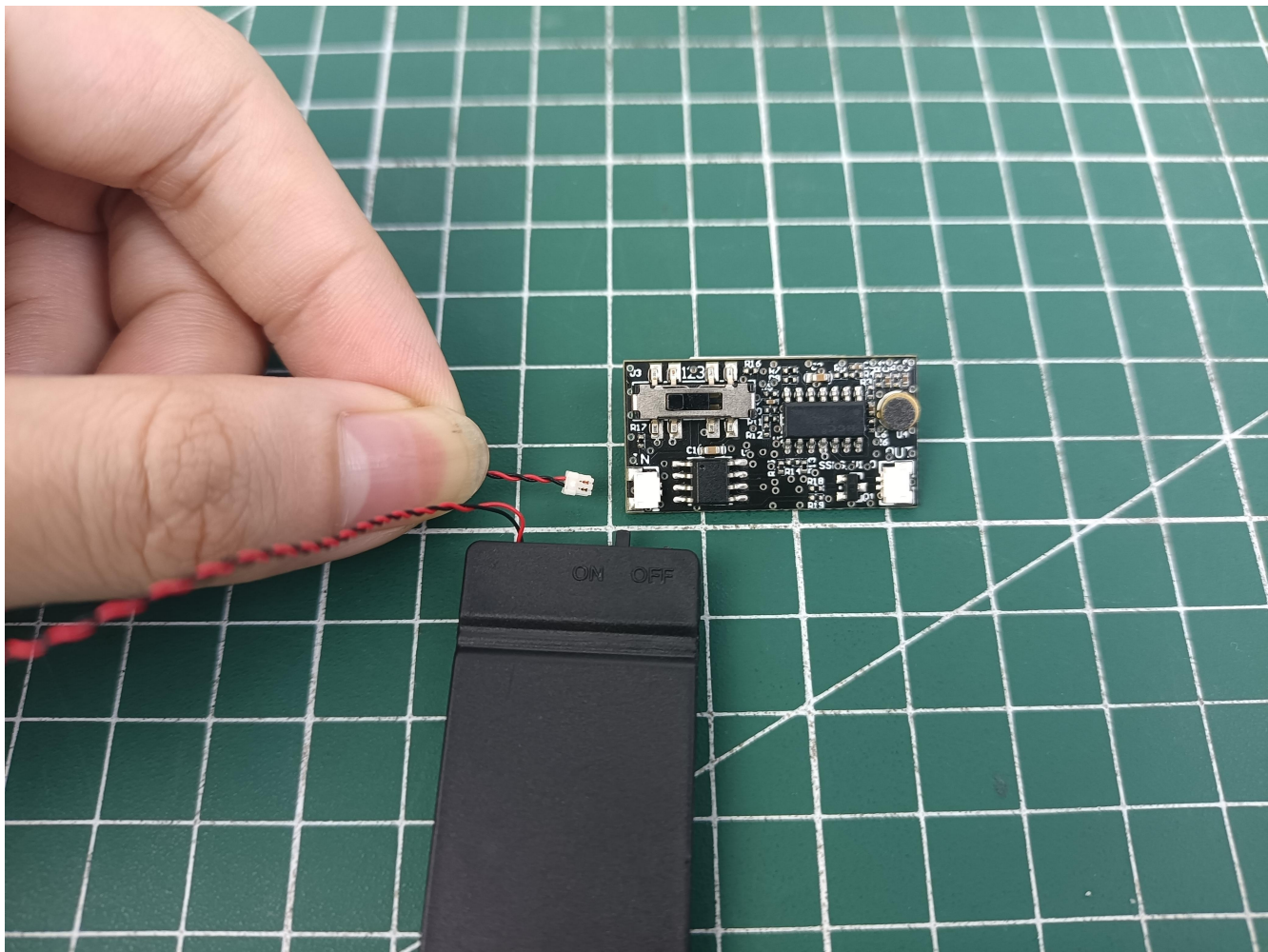

Take out the accessories in the "1" bag.

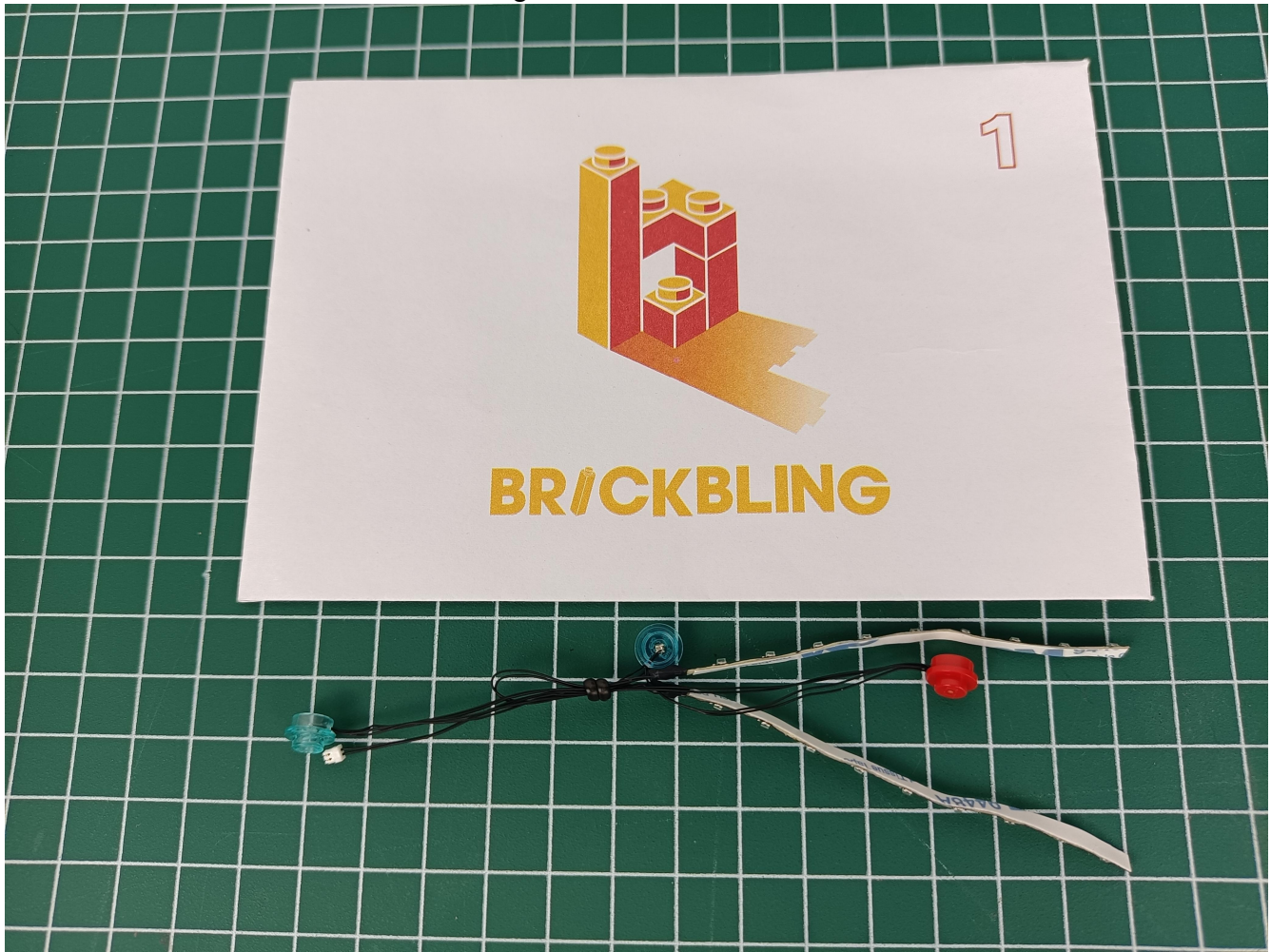

Connect the accessories to the voice control module.

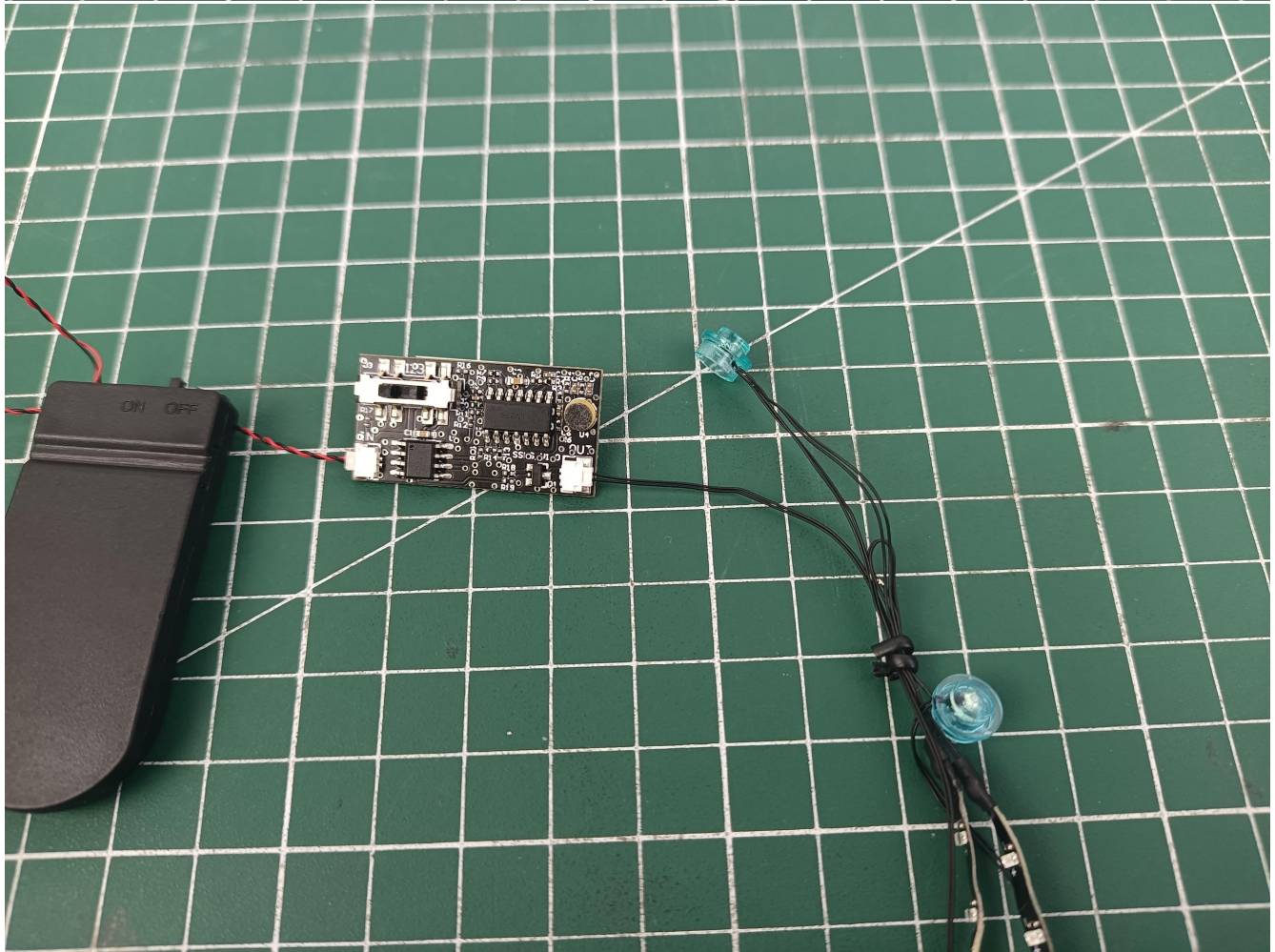
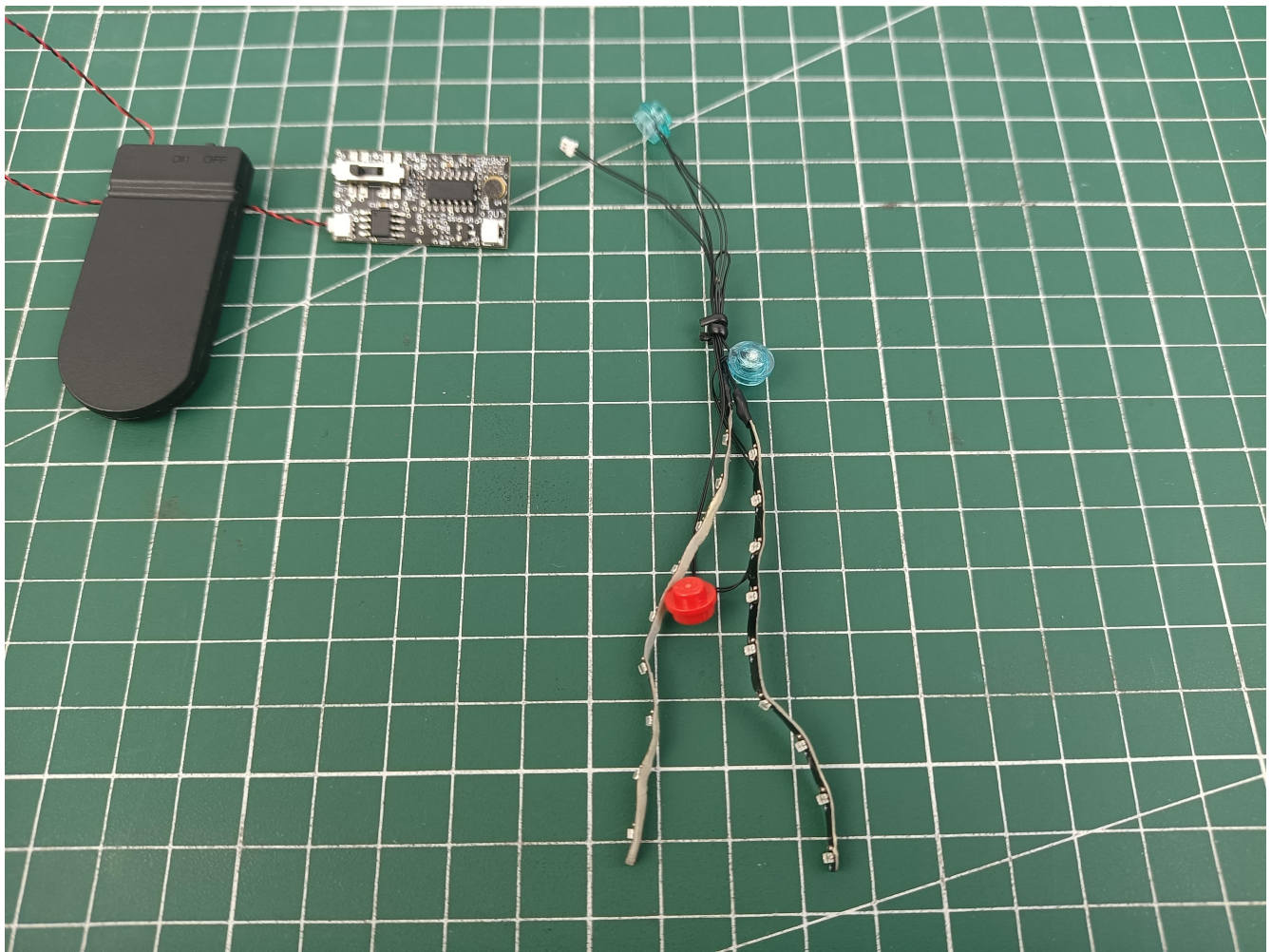

Turn on the power switch of the Flat Battery Pack and check whether the accessories are abnormal. **If there is any abnormality, please contact us in time!**

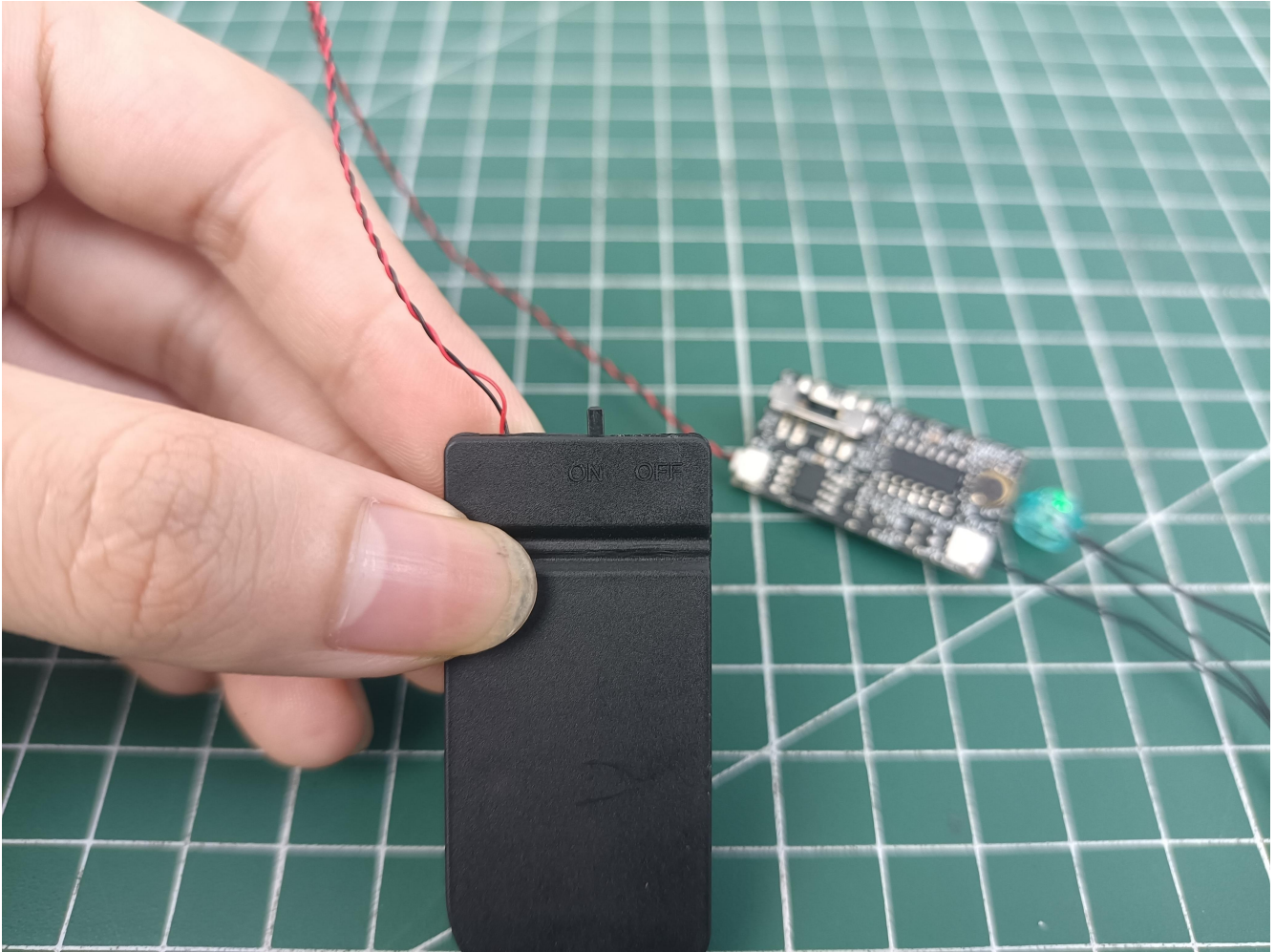

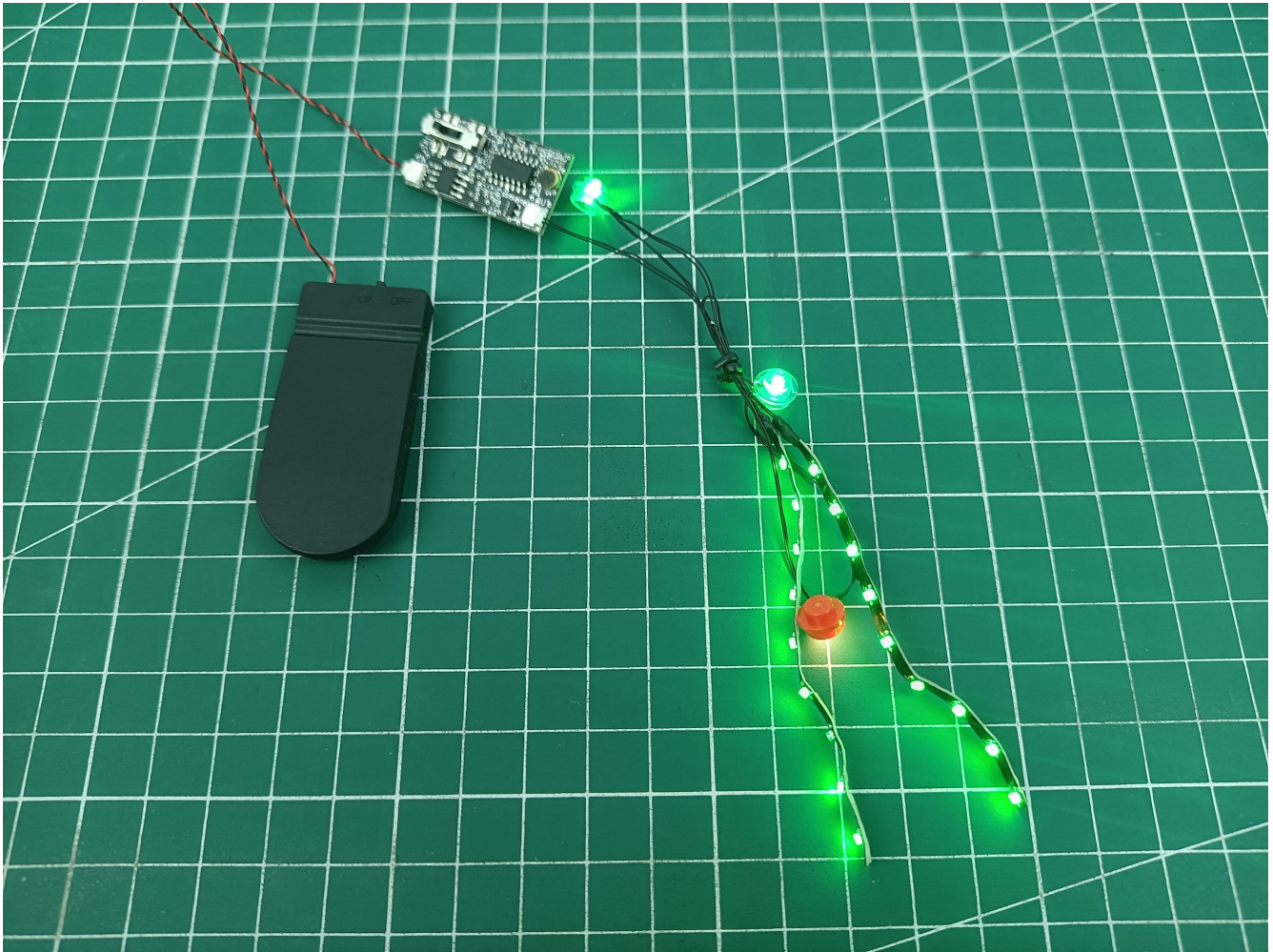

Separate Flat Battery Pack from voice control module.

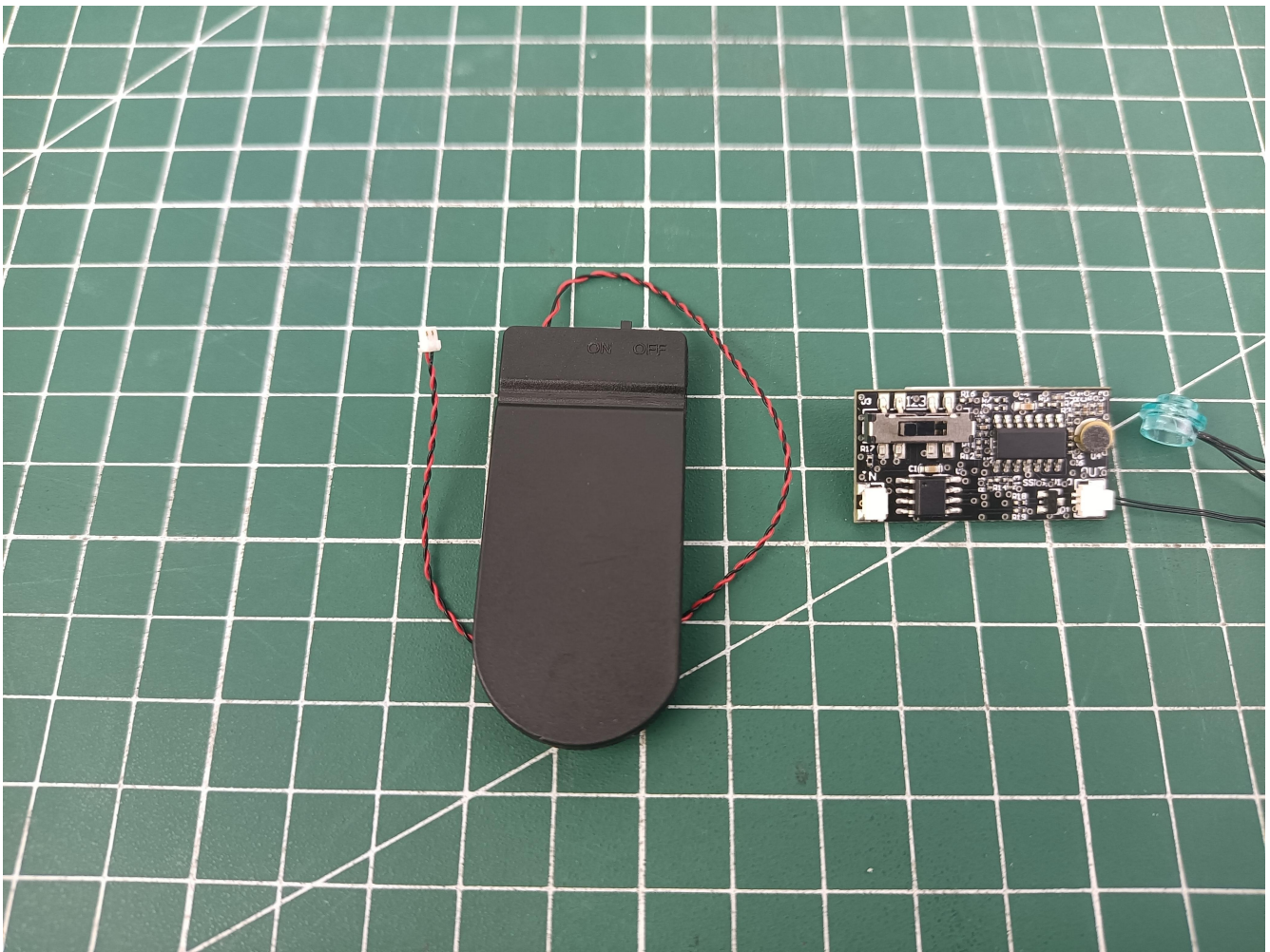

Take out the USB power cord and connect it to the voice control module.

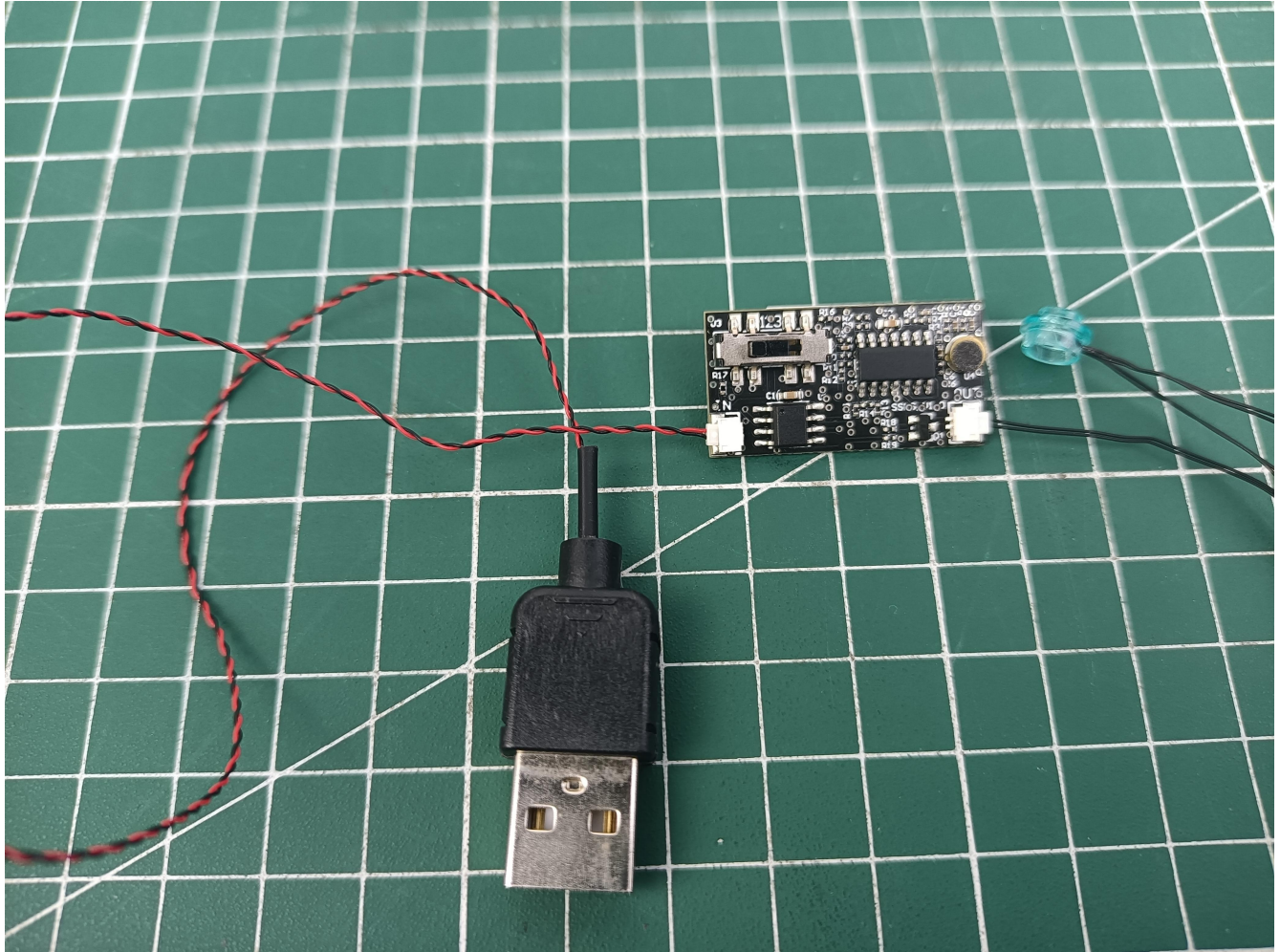
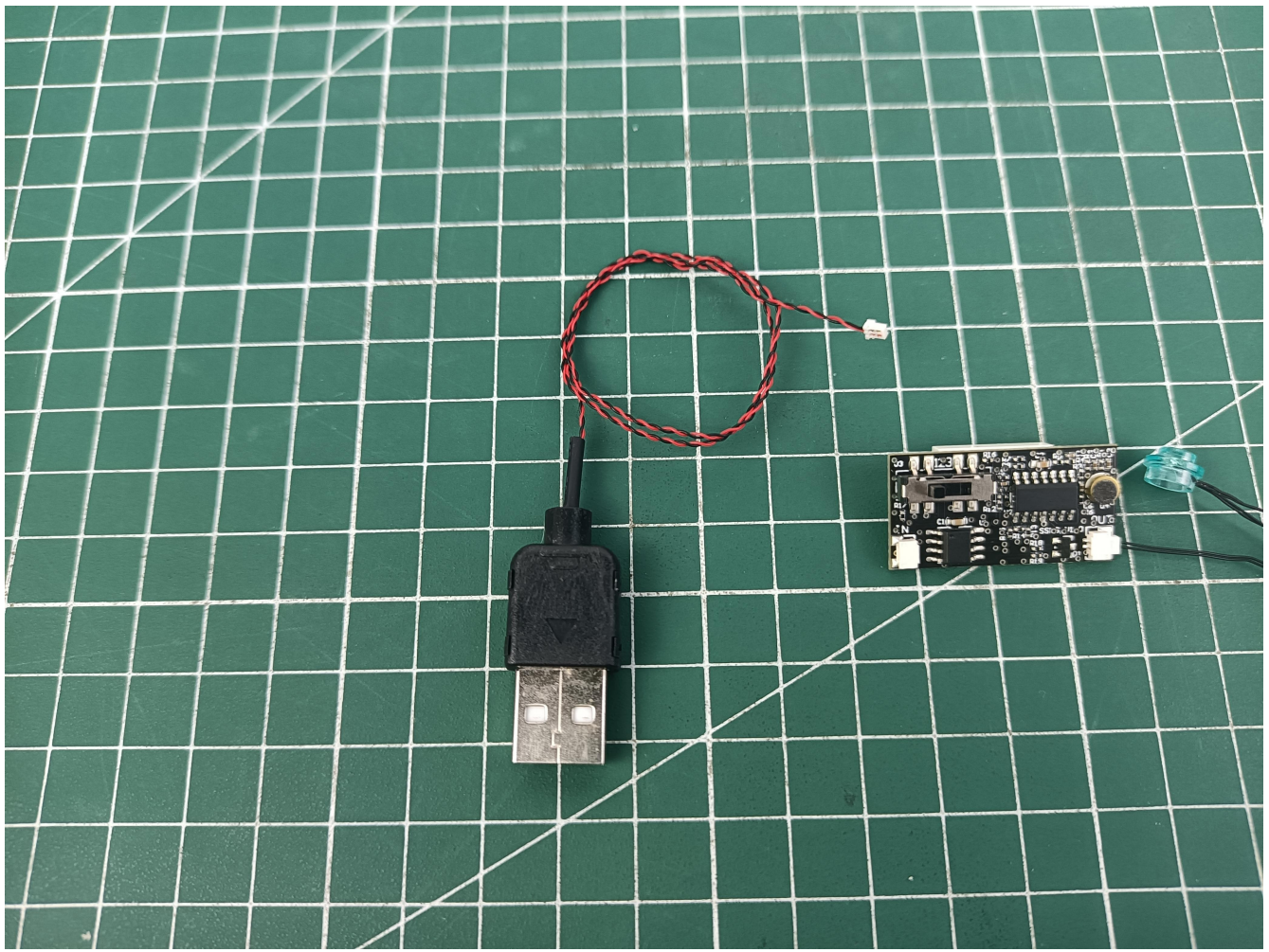

Connect the USB power cord to the power bank.

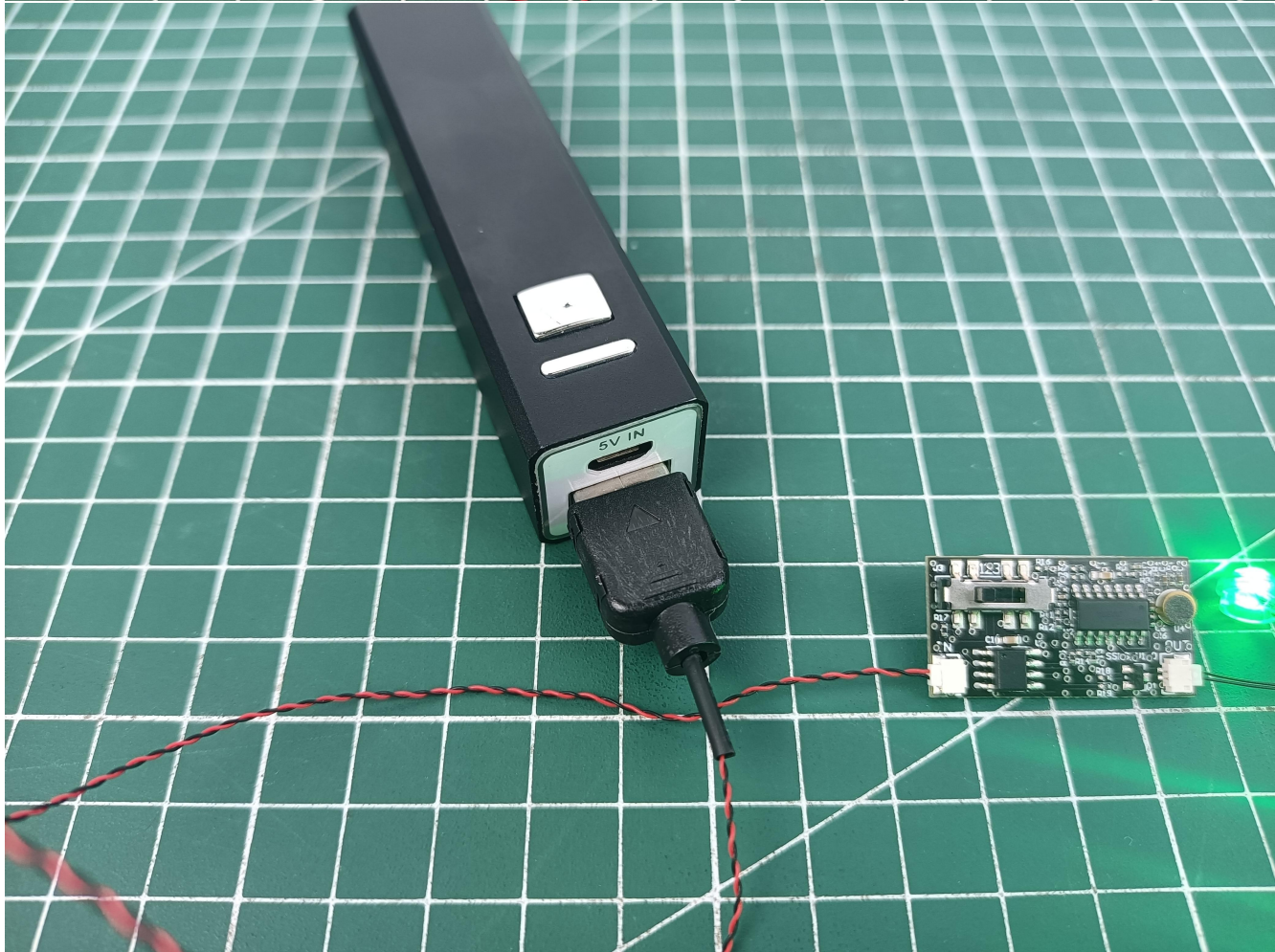
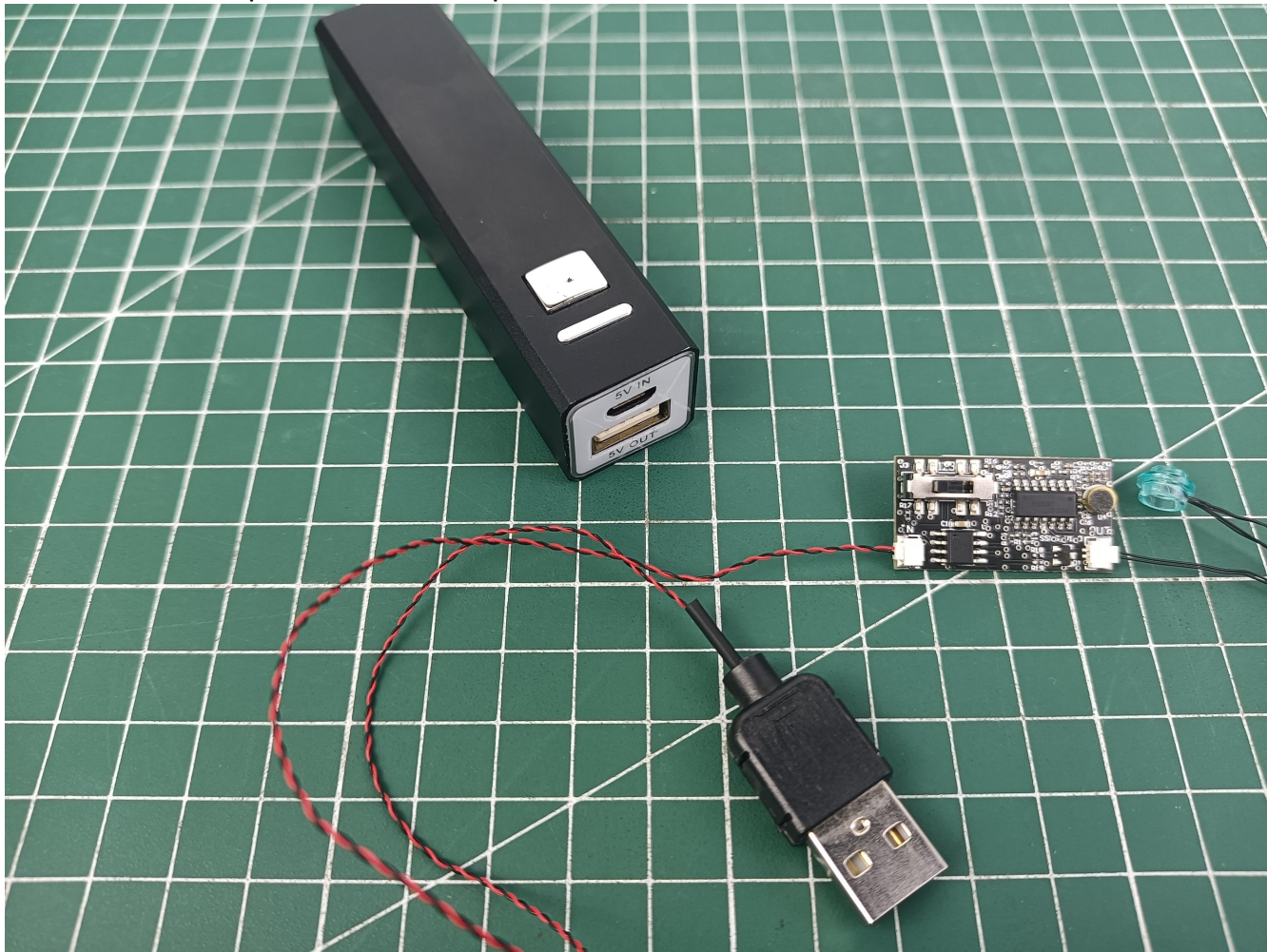

Check whether the accessories are abnormal.

If there is an abnormality, please contact us in time!

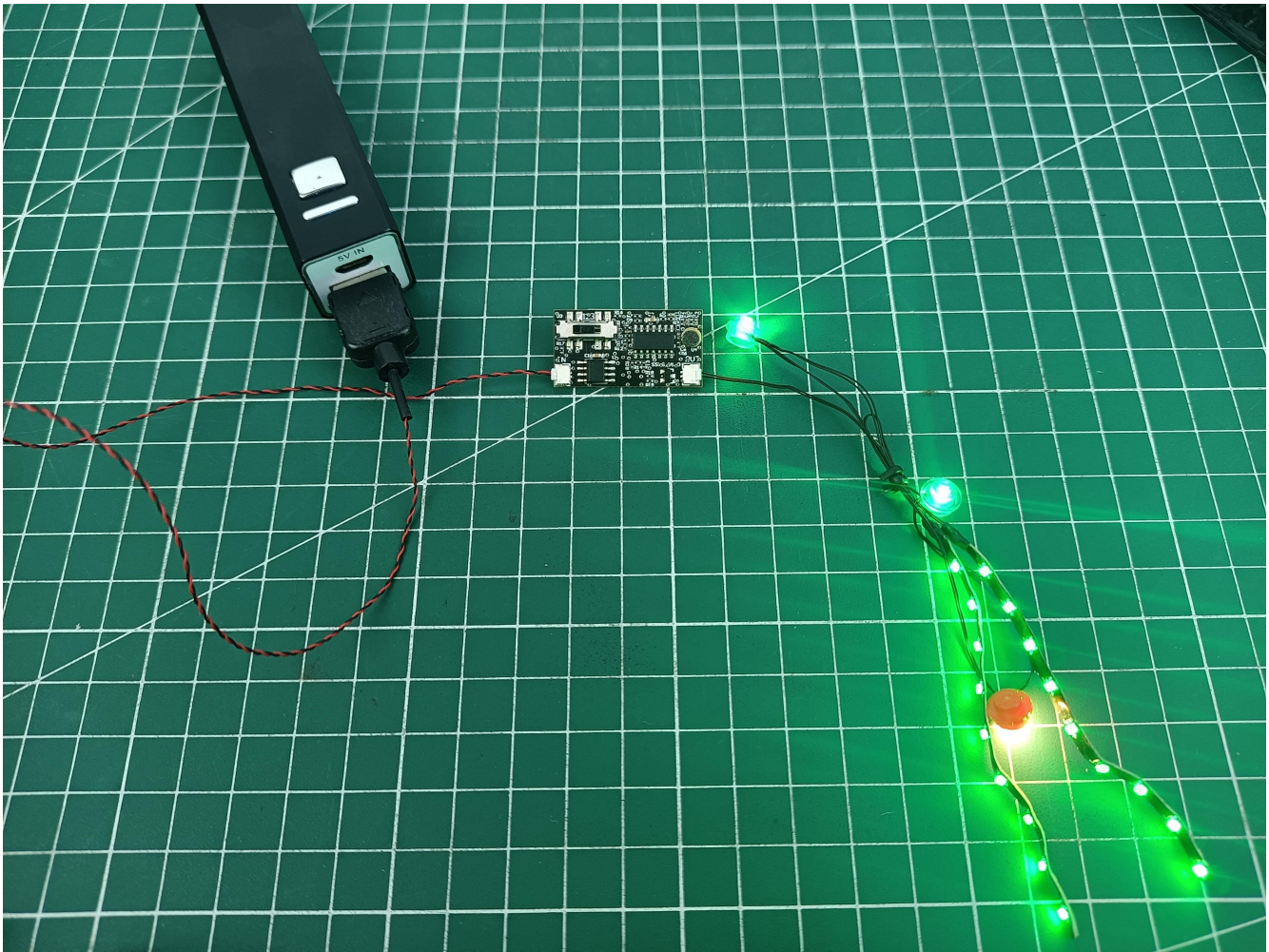

Separate all accessories.

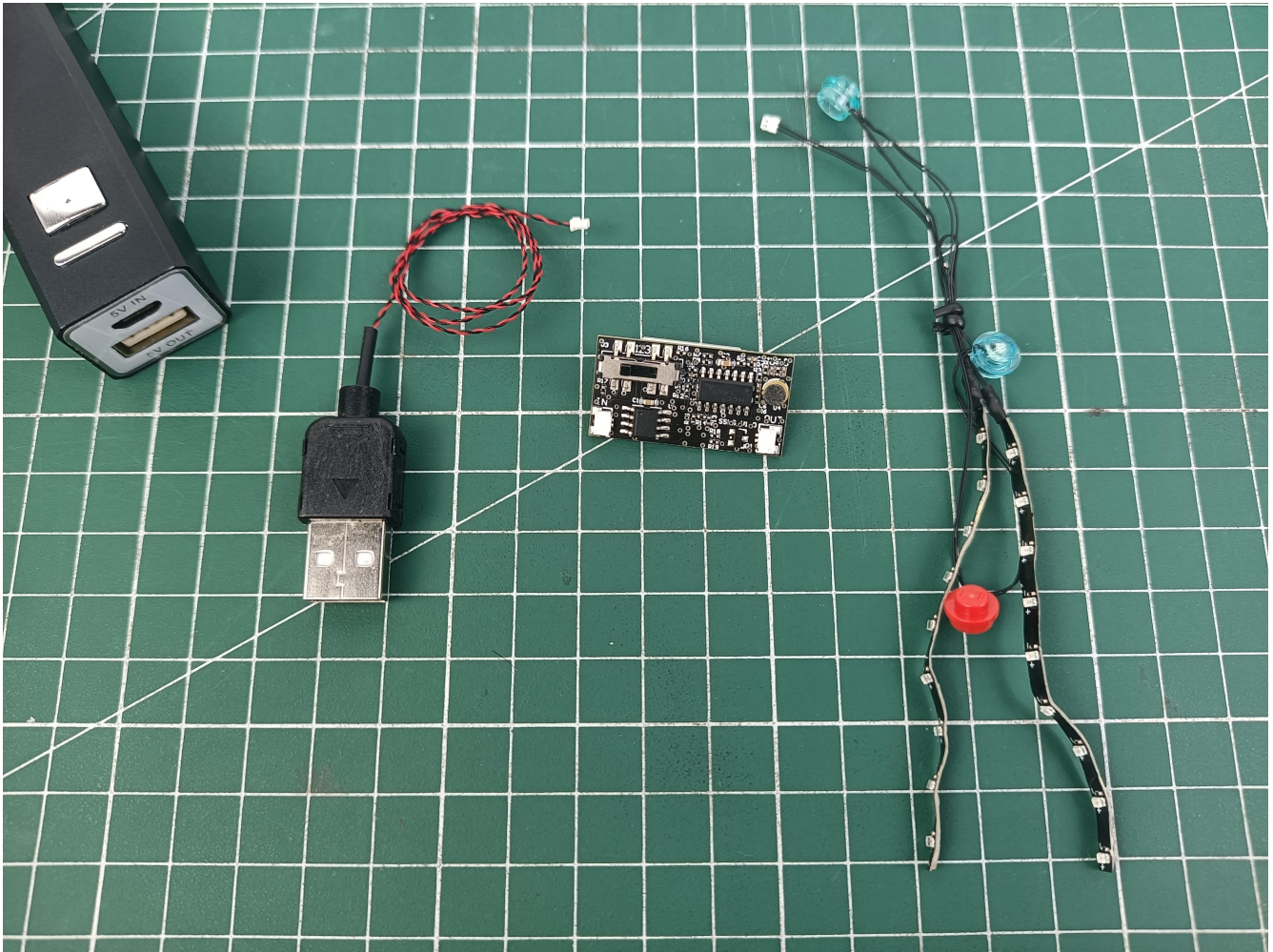

Put the accessory as shown in the "1" bag to prevent it from being lost.



Put the remaining accessories back in place to prevent loss.

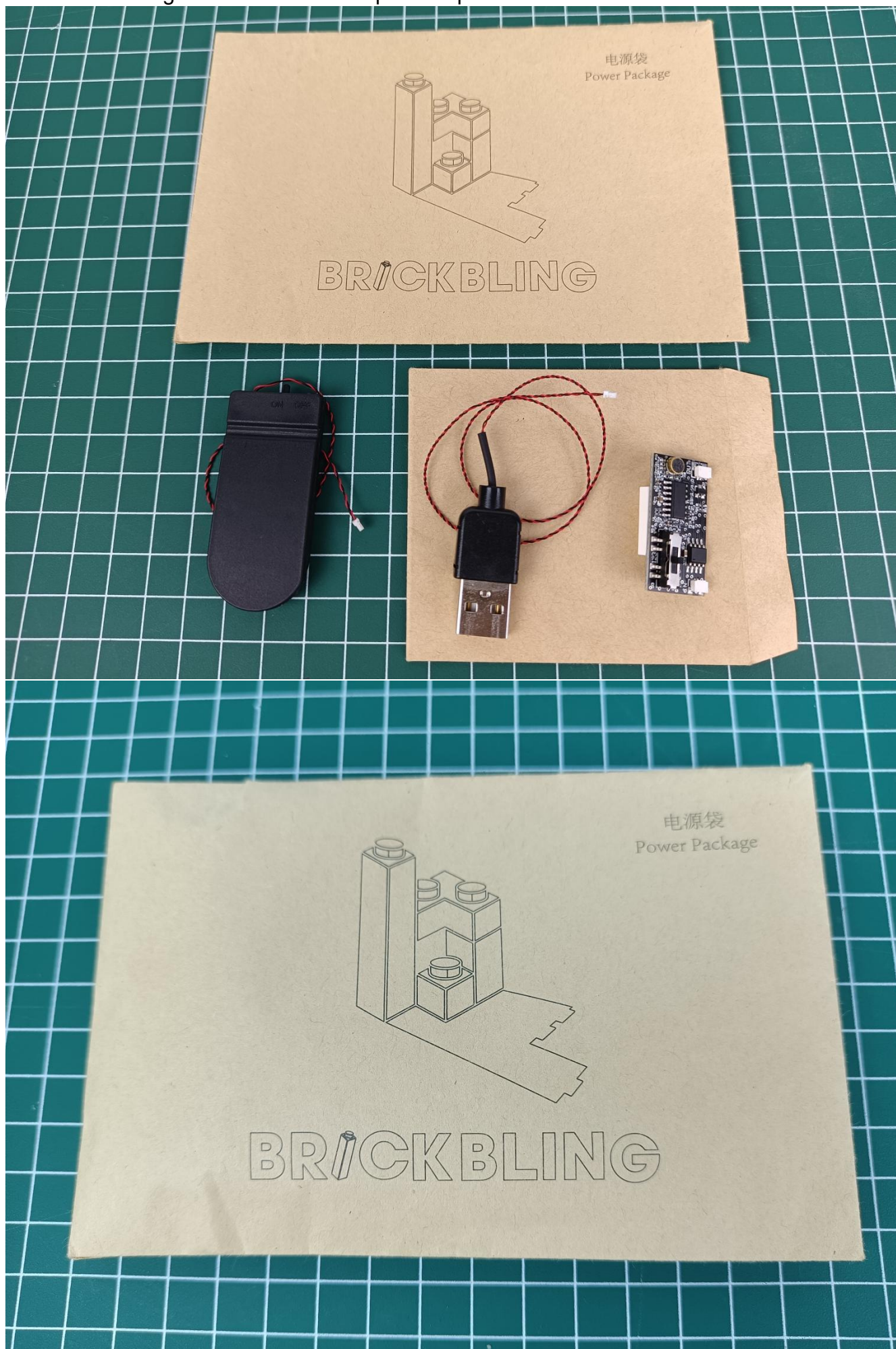

start installation:

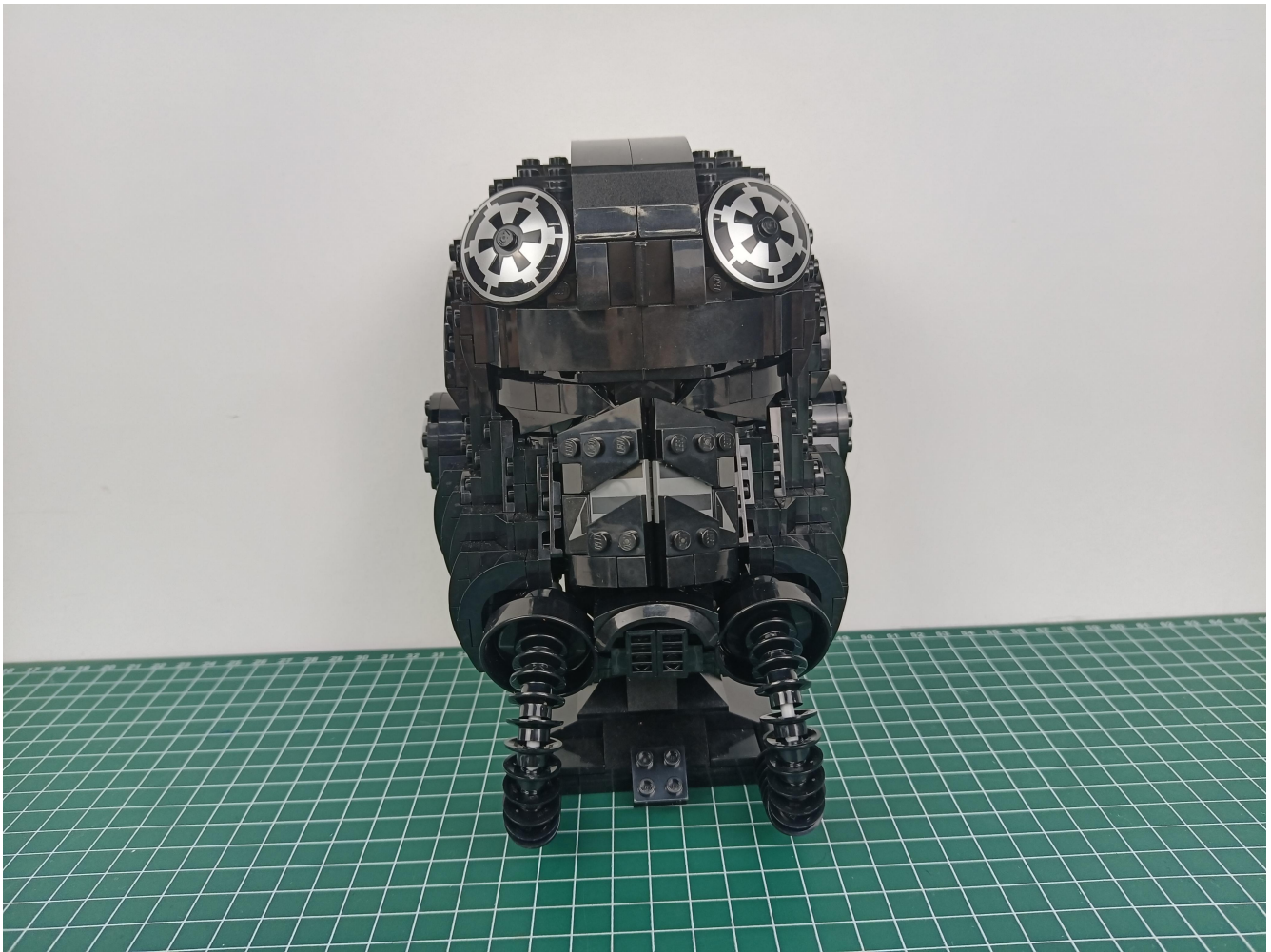

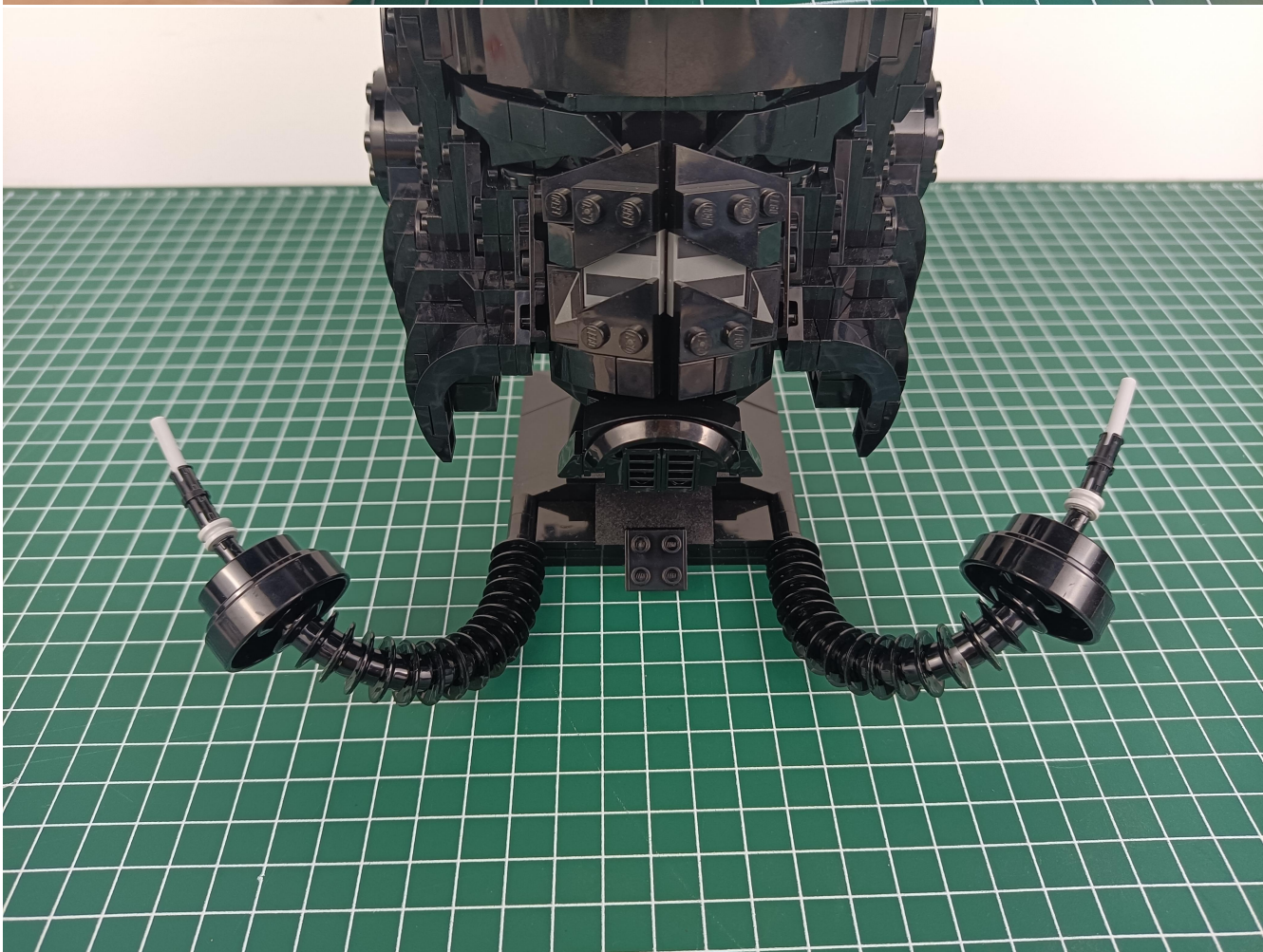

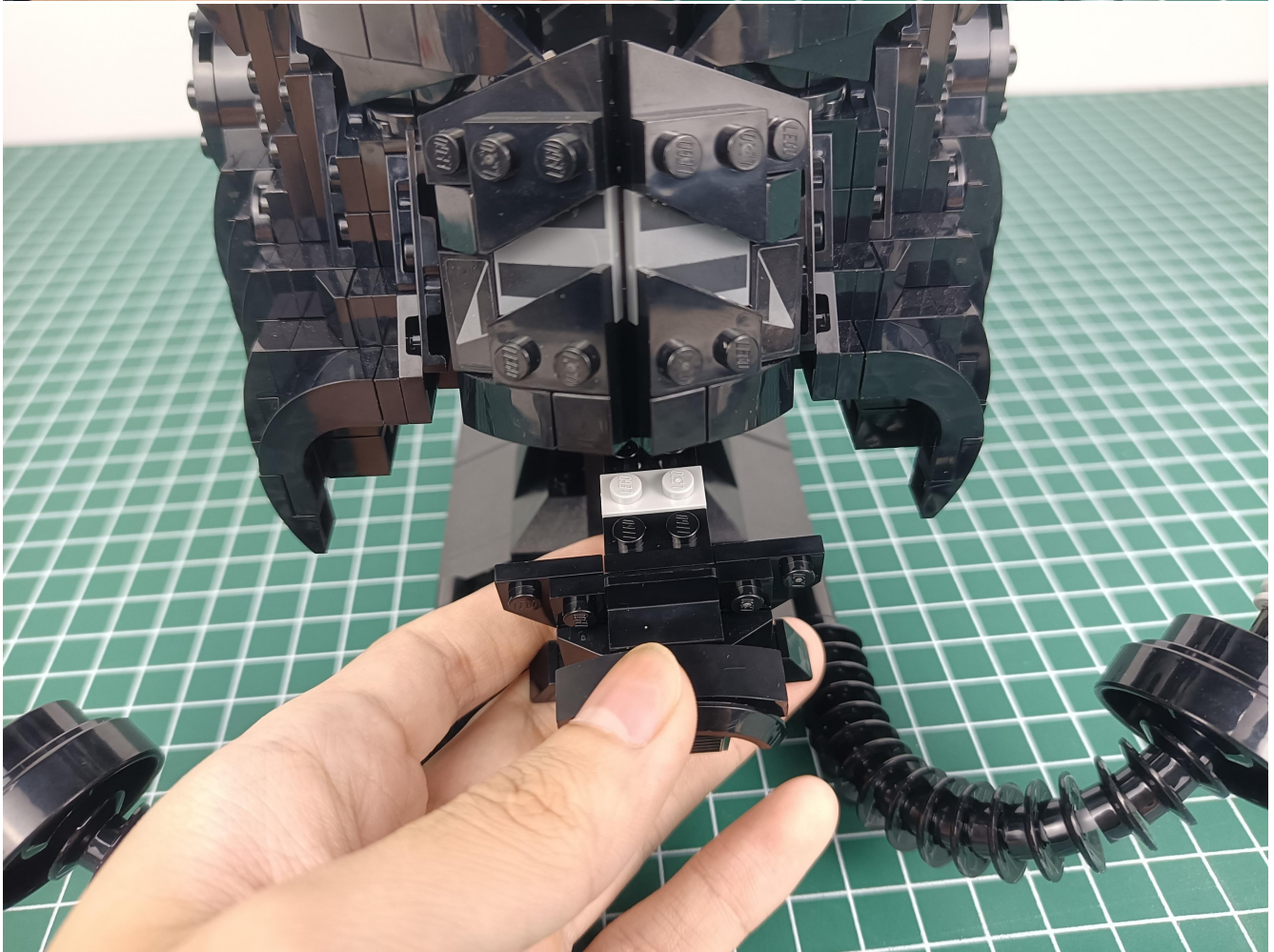

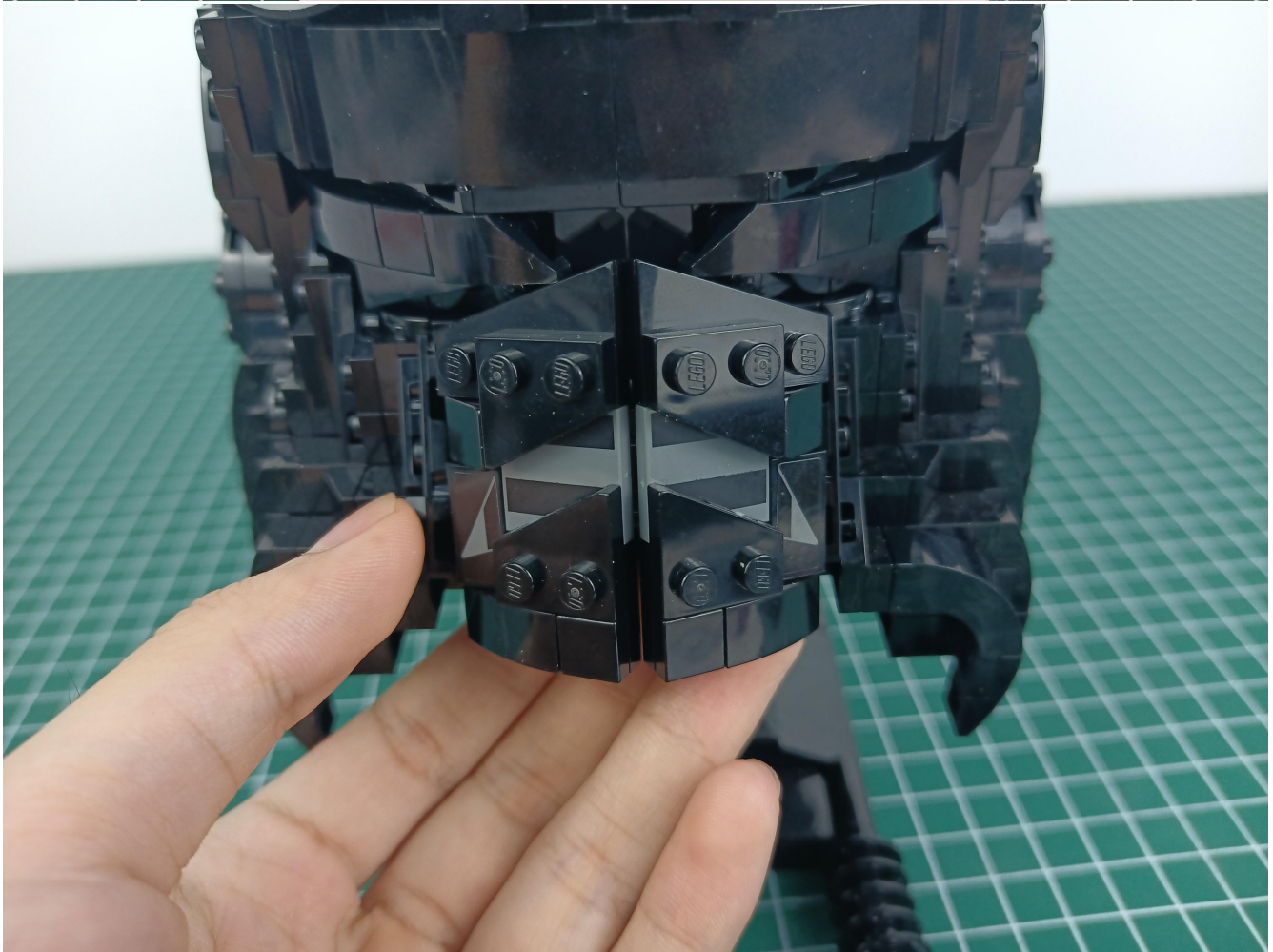
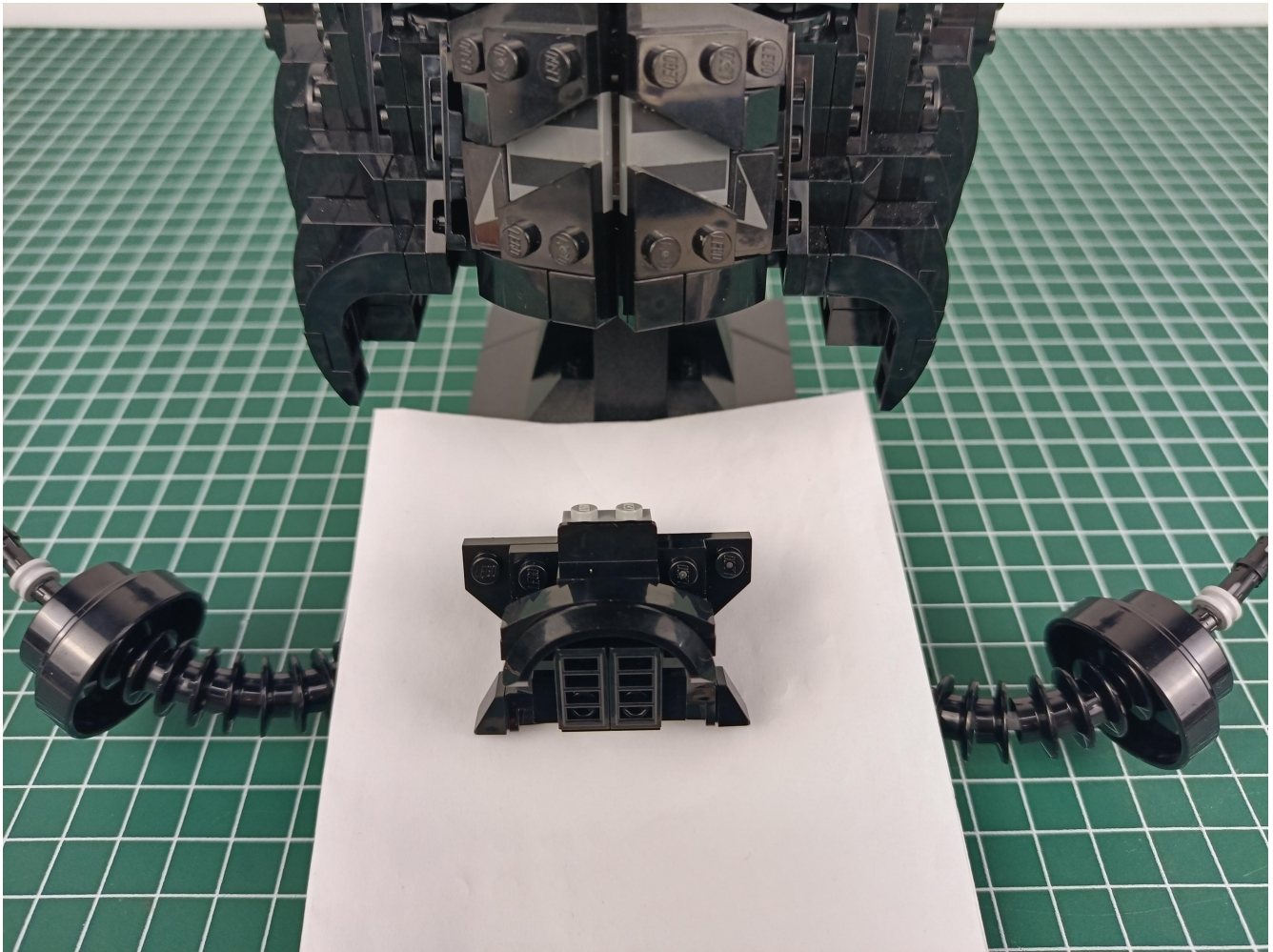

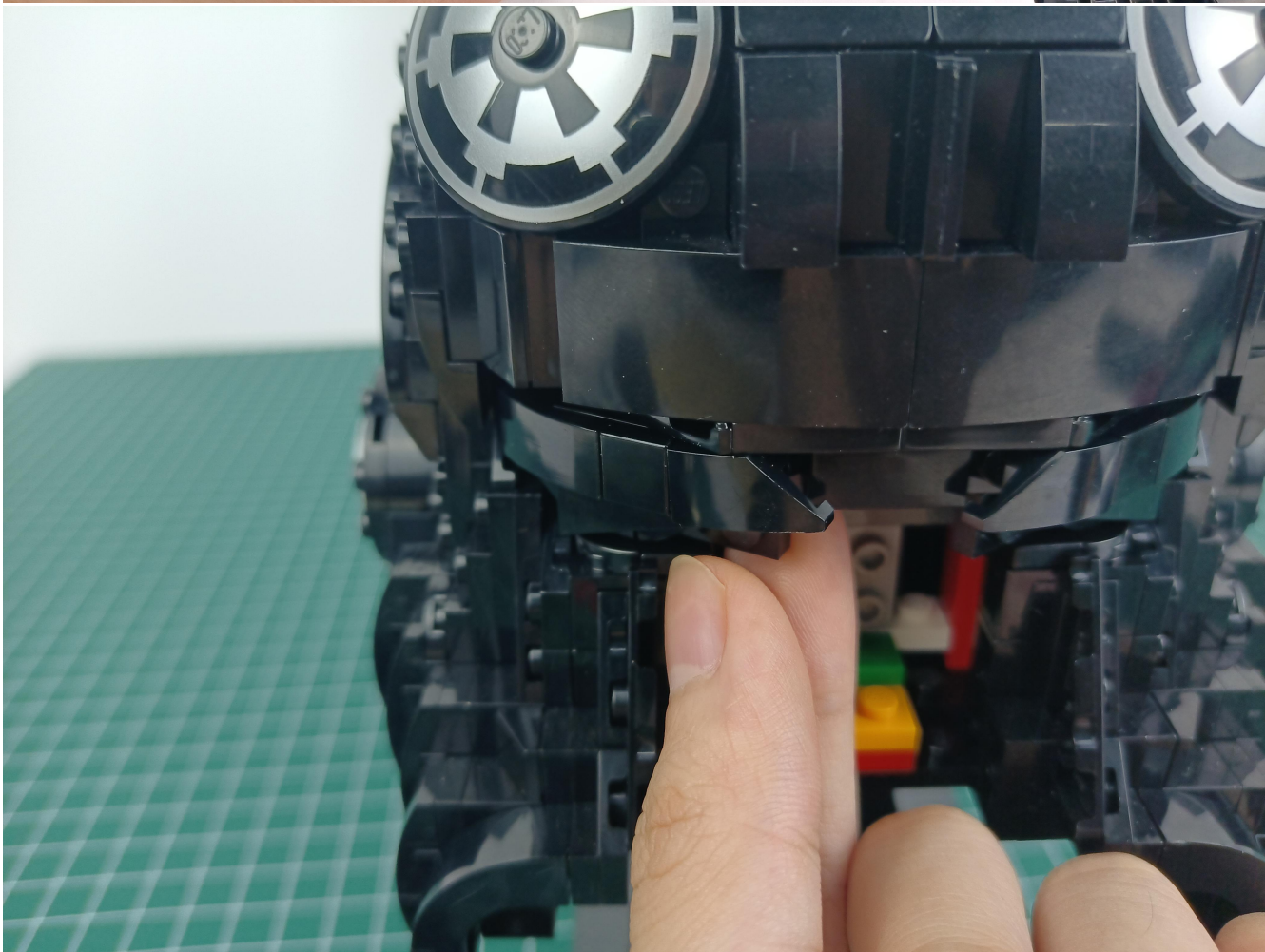
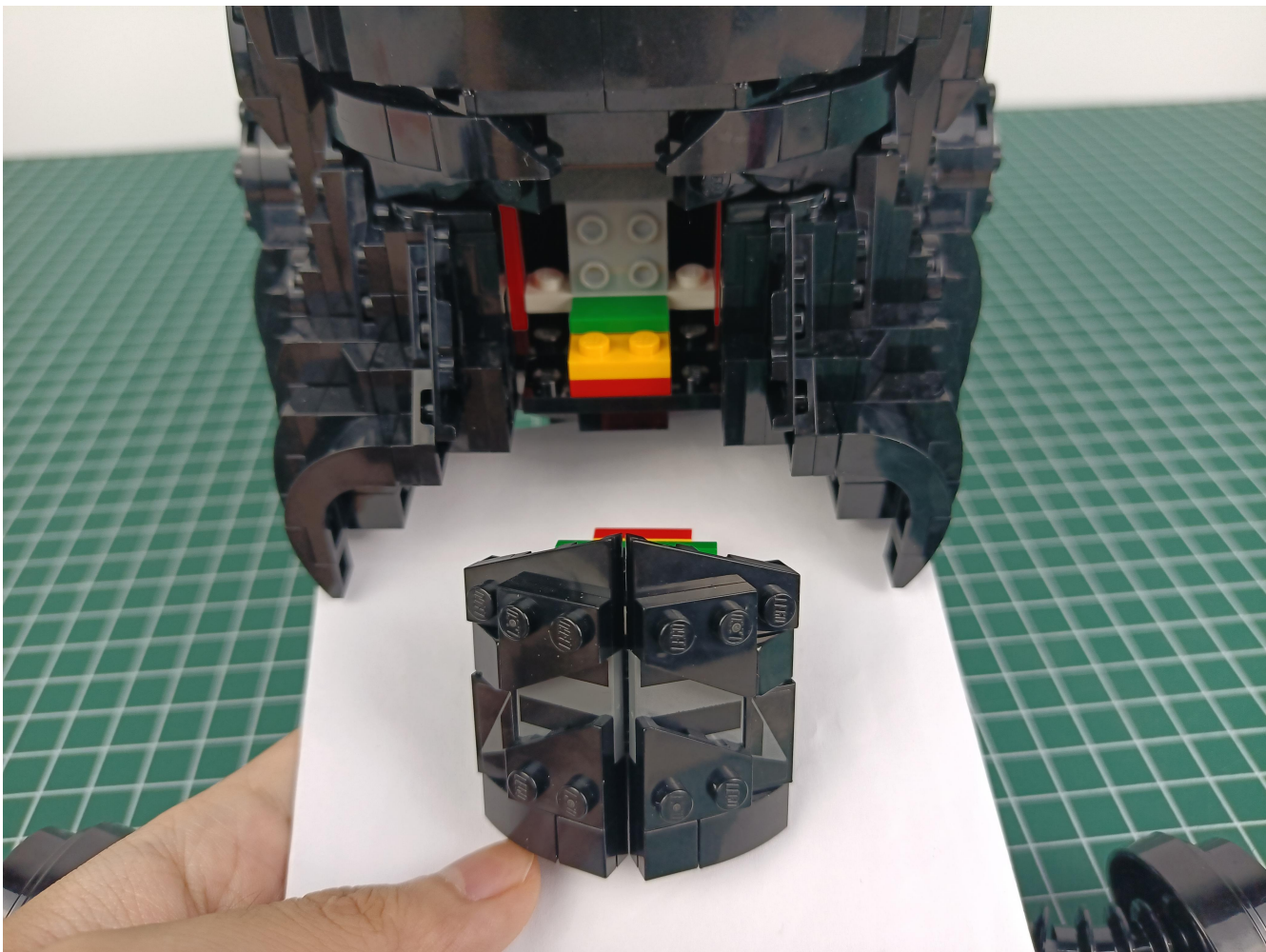

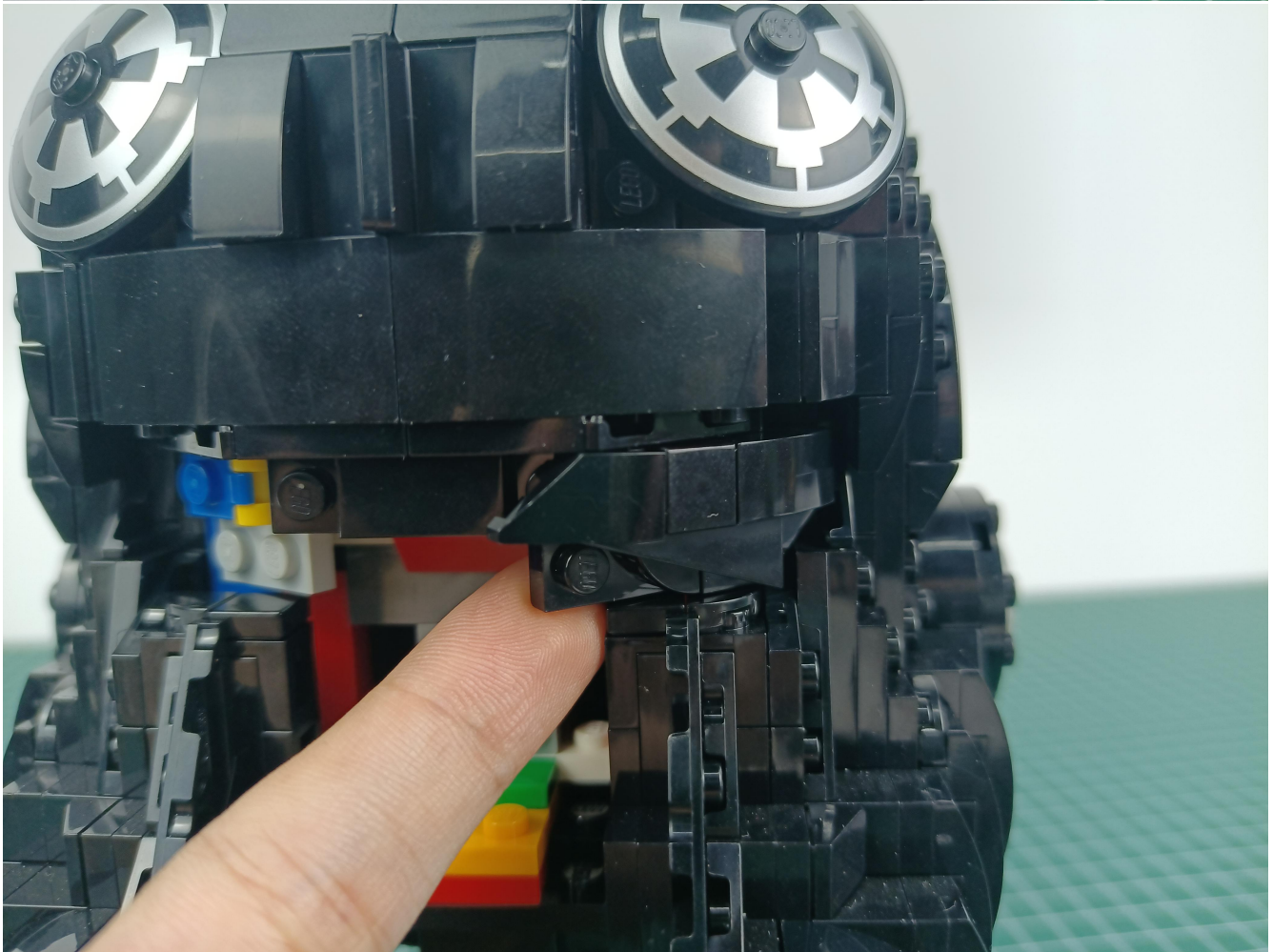
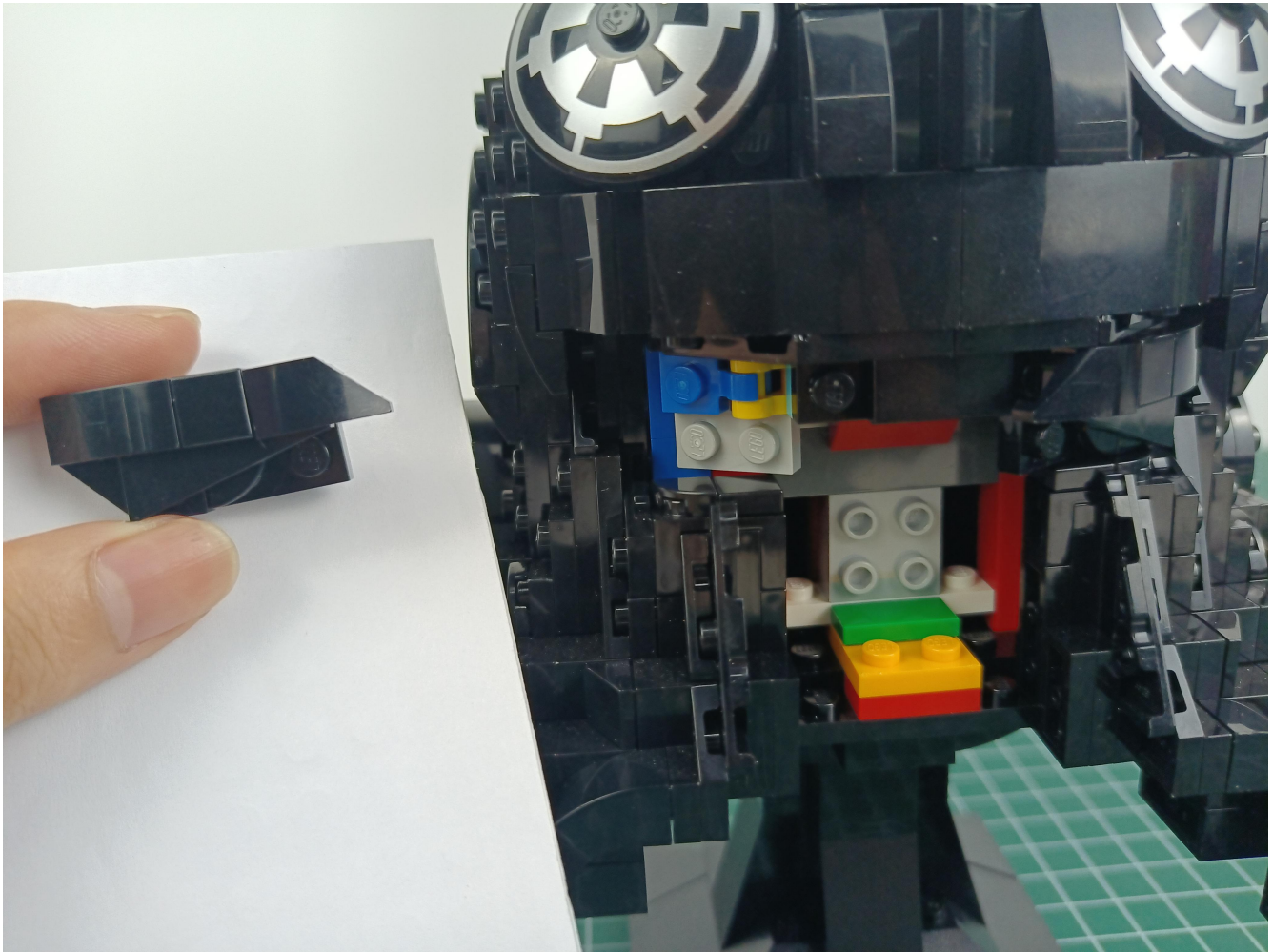

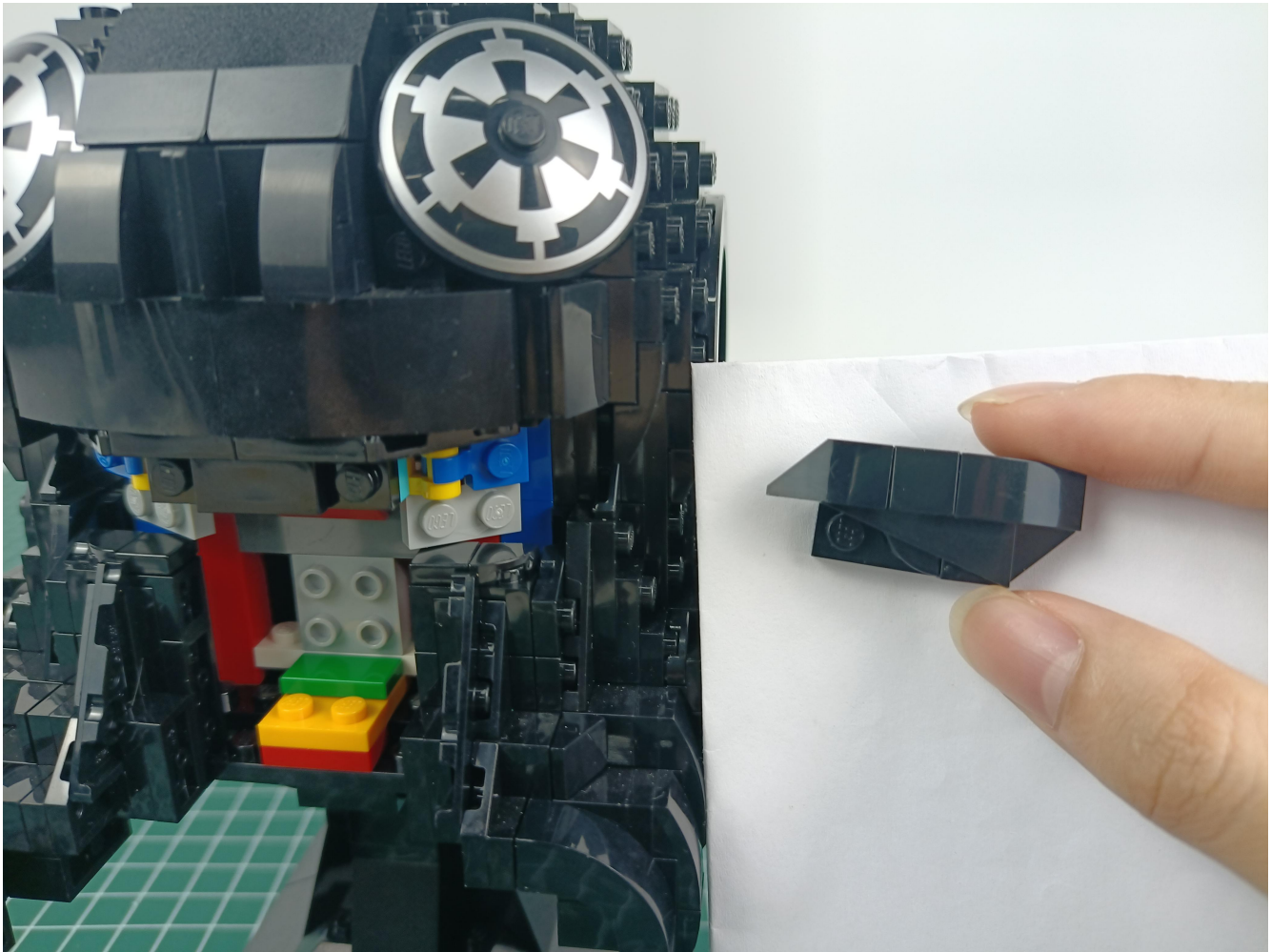

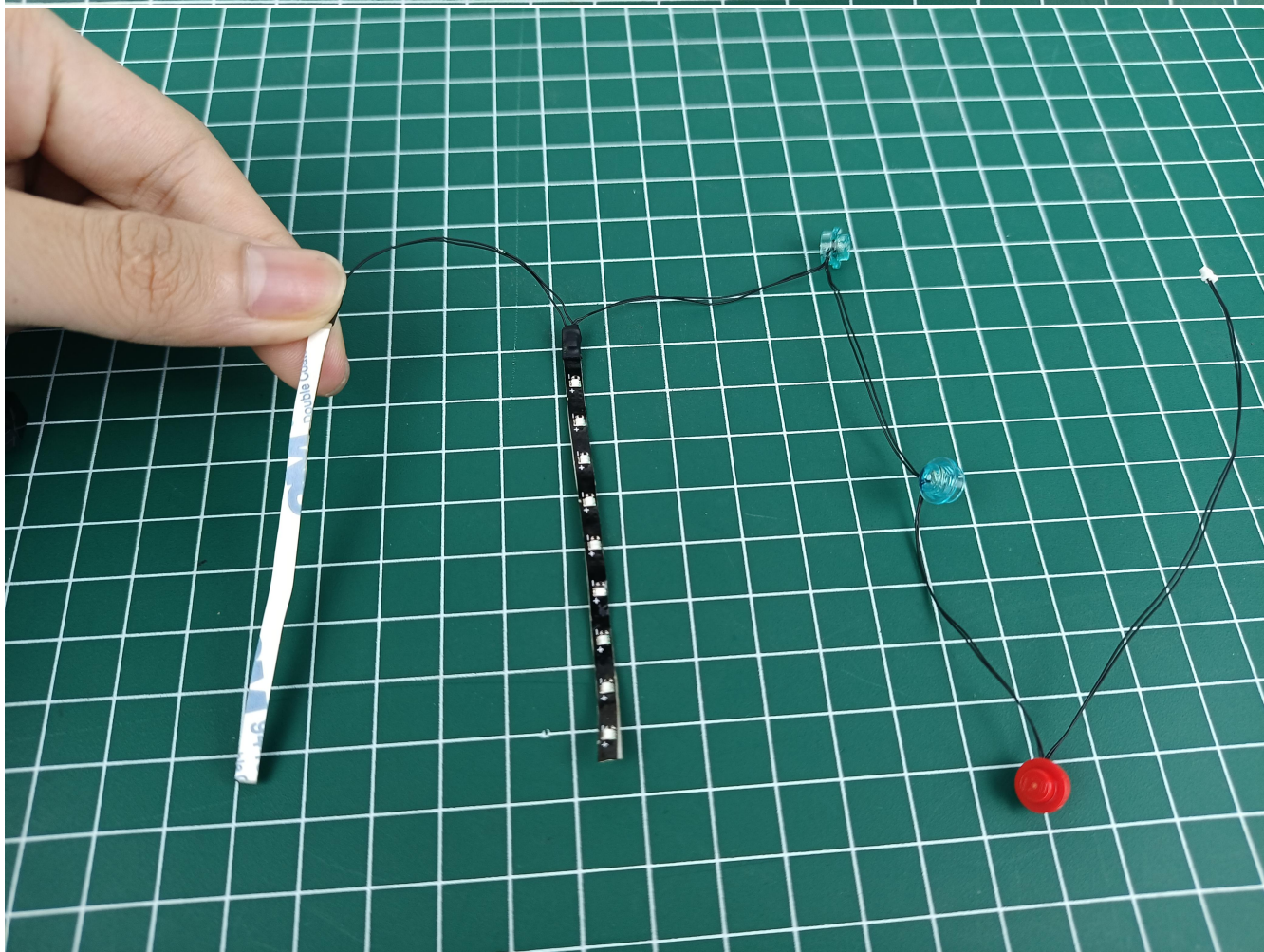
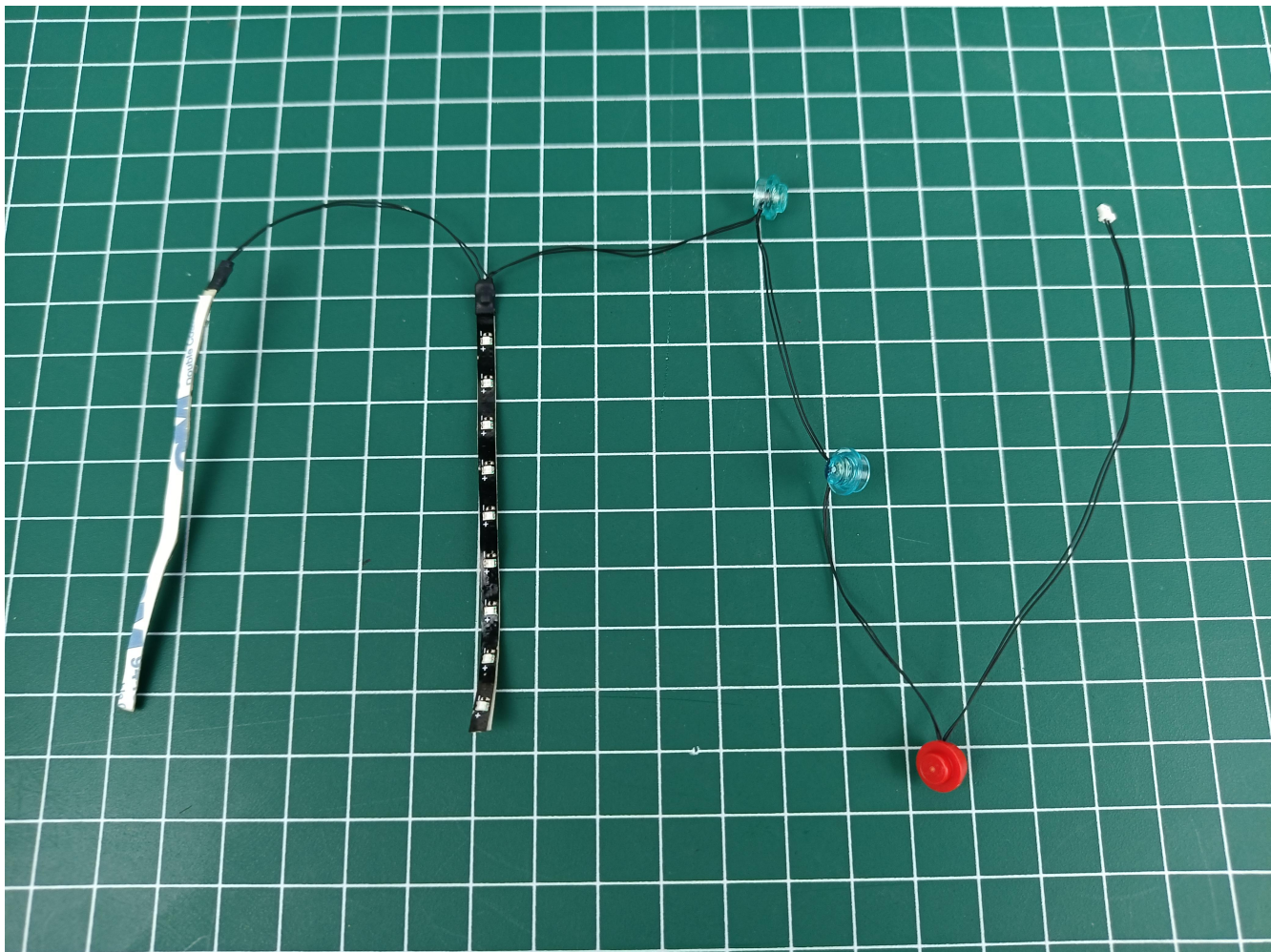

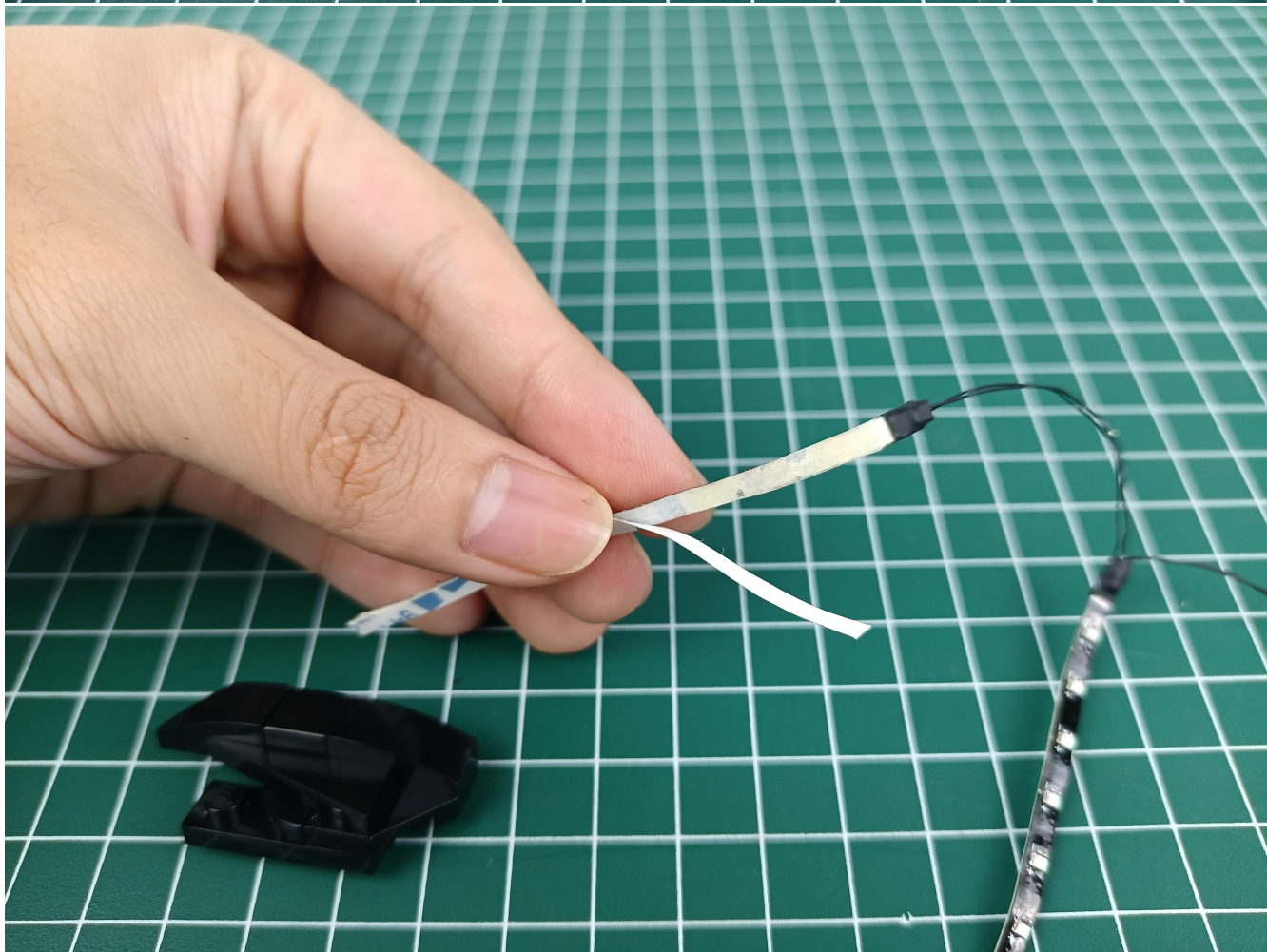
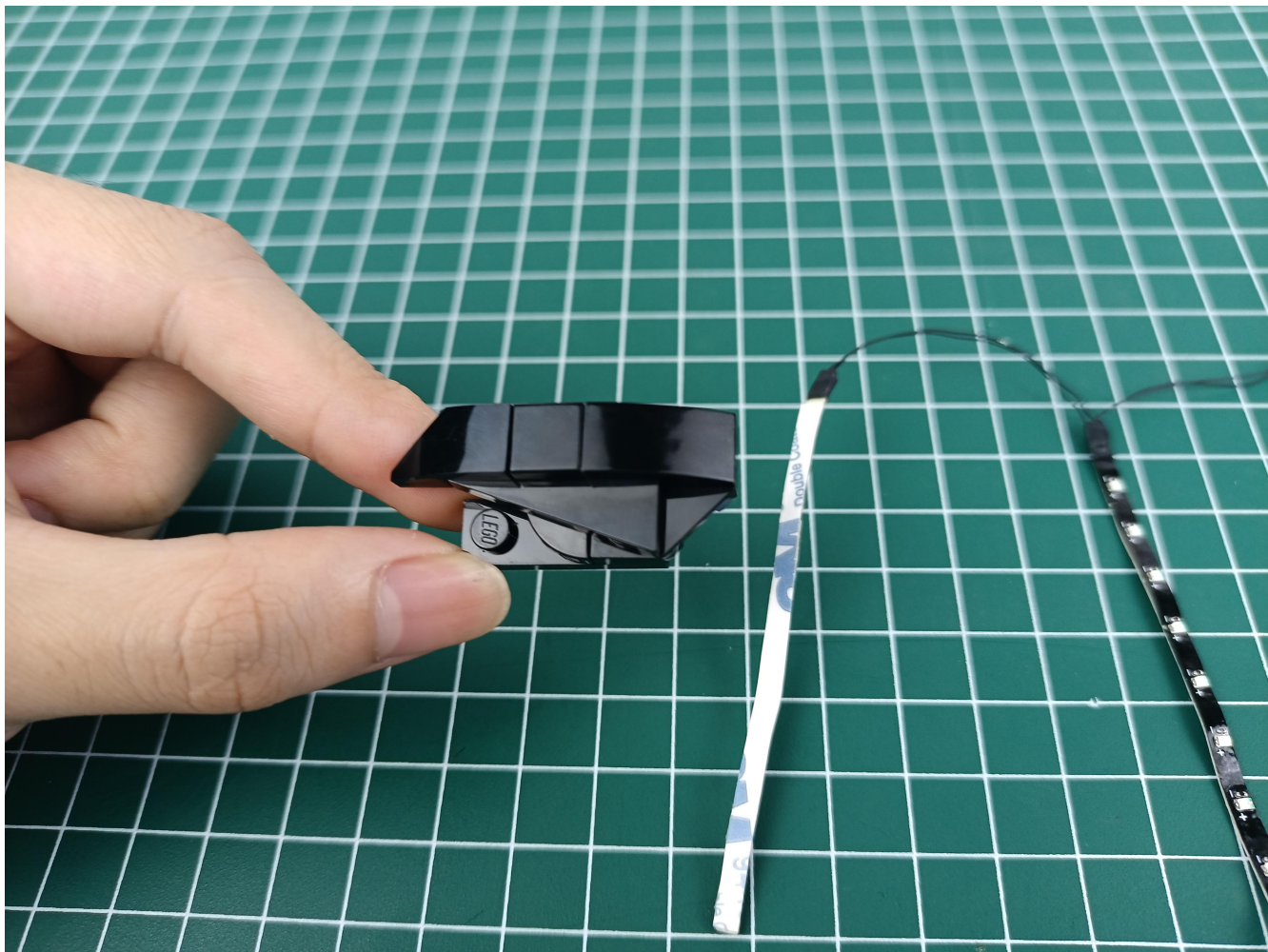

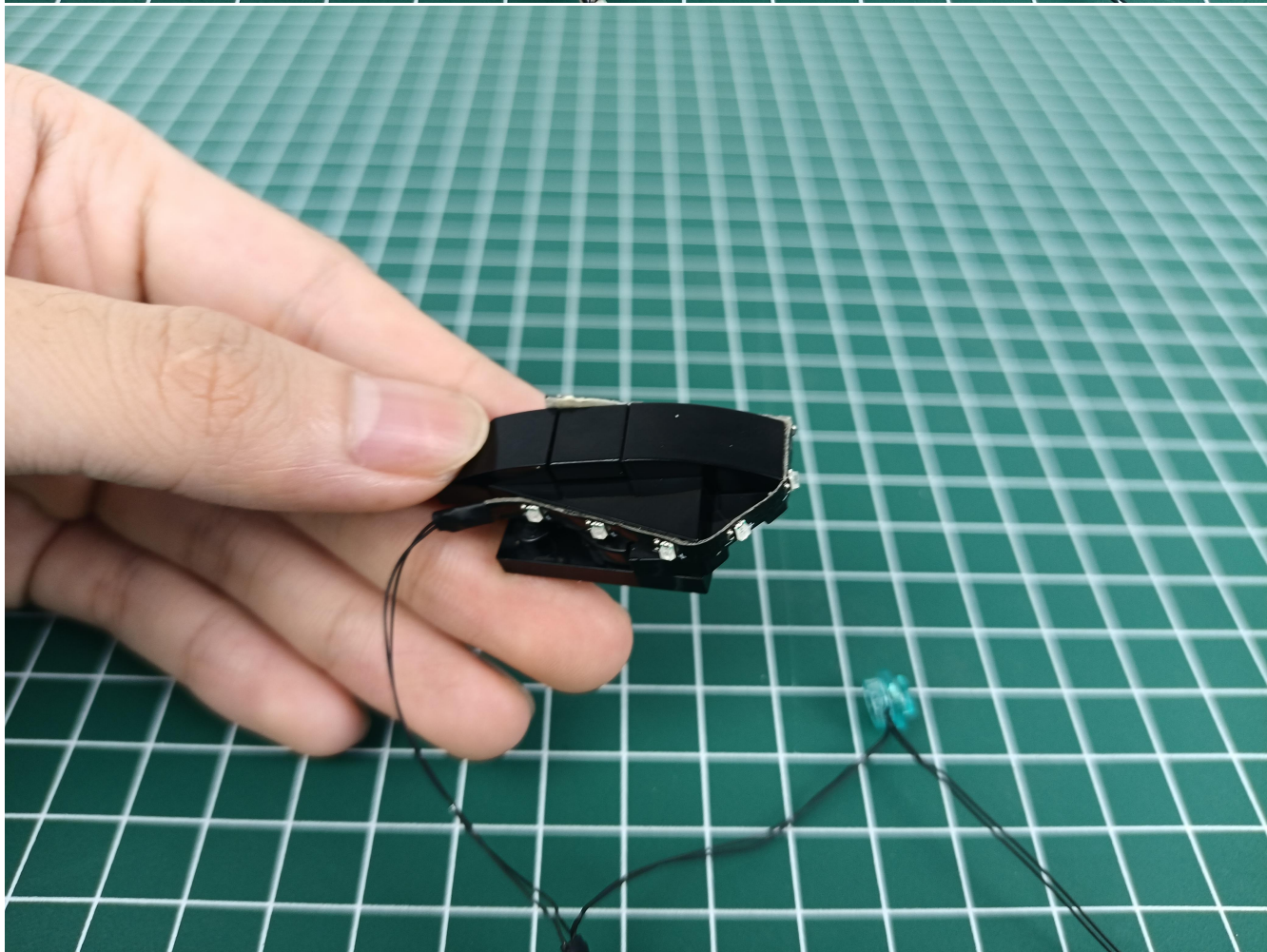
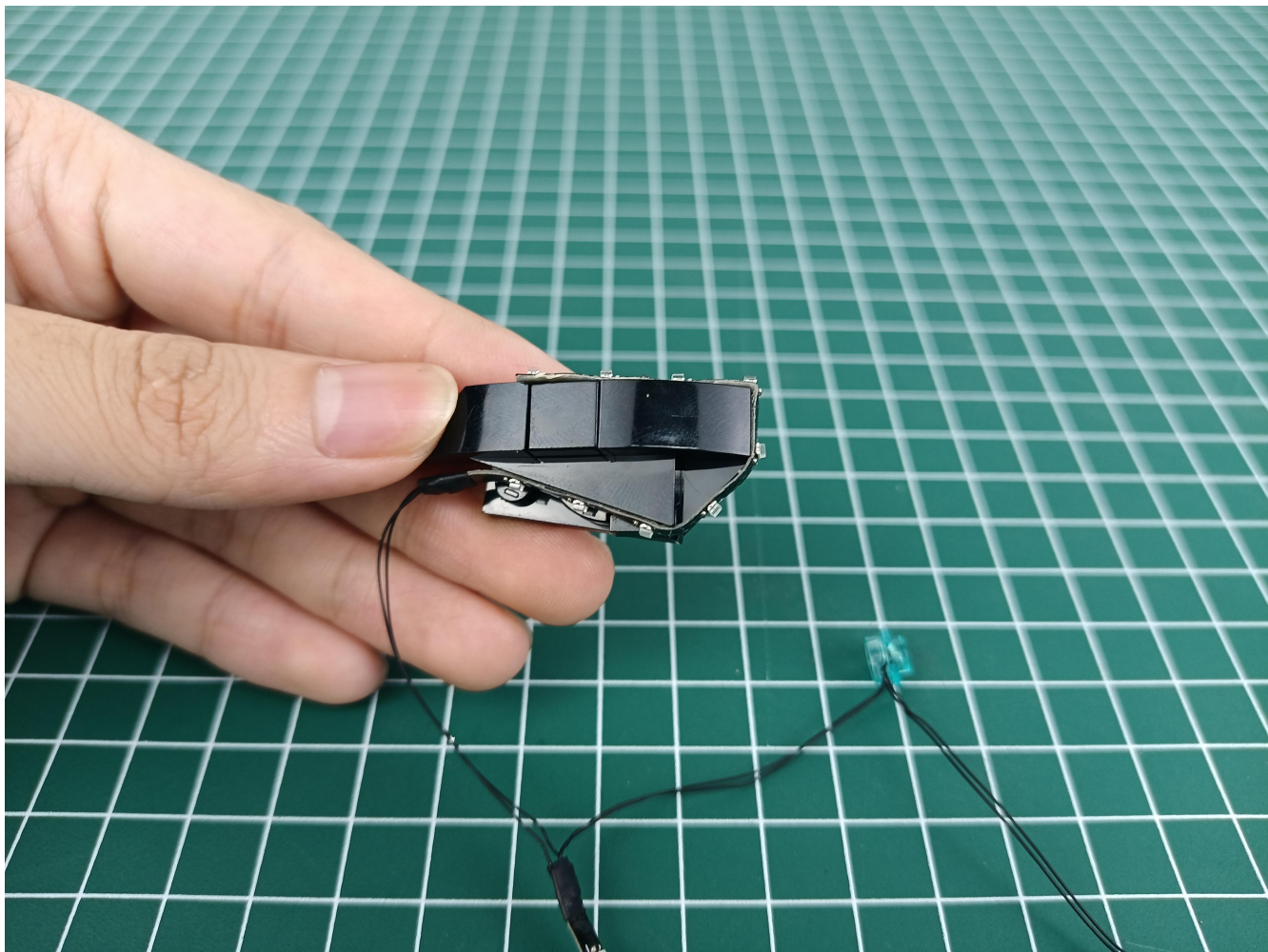

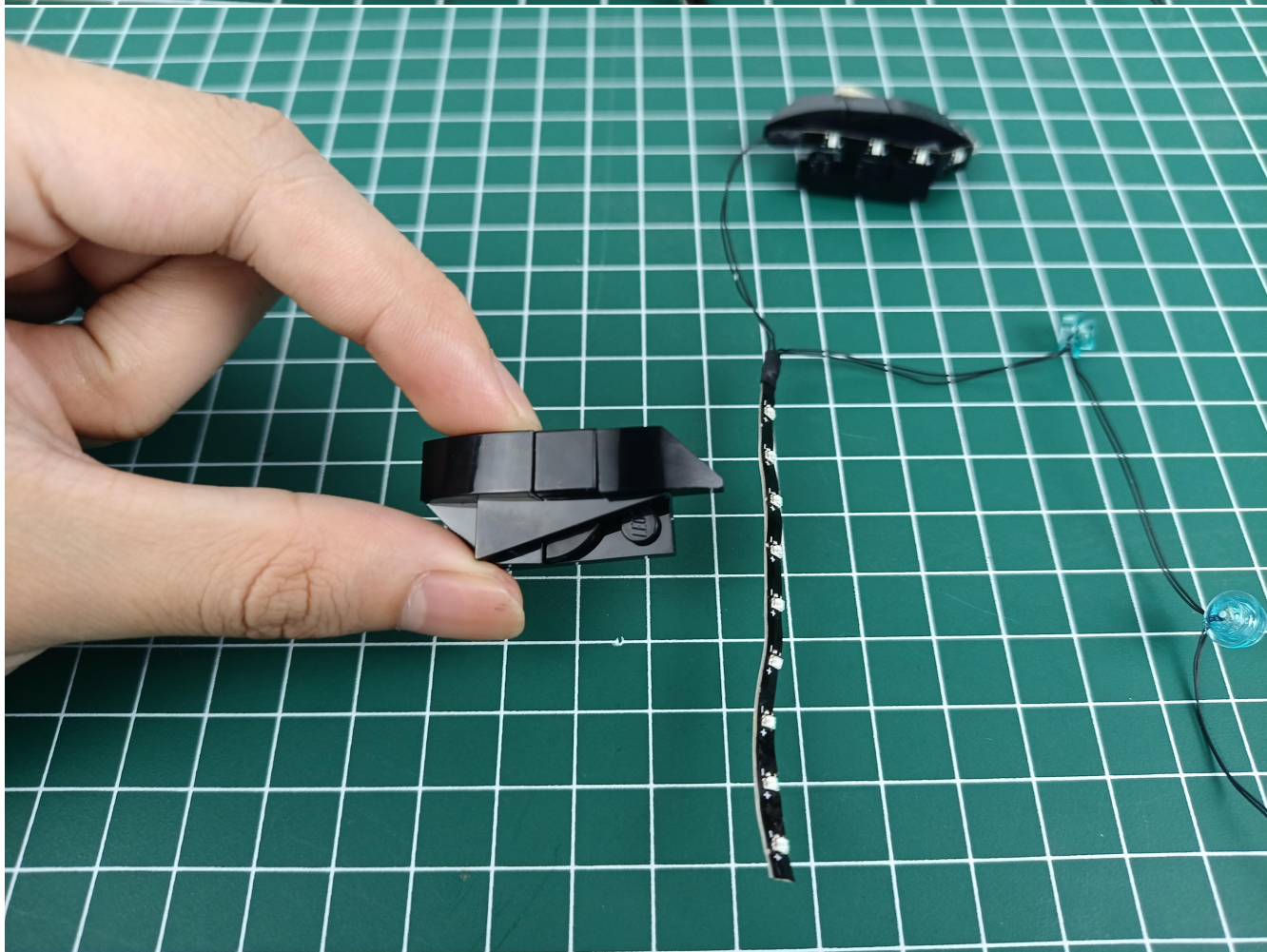

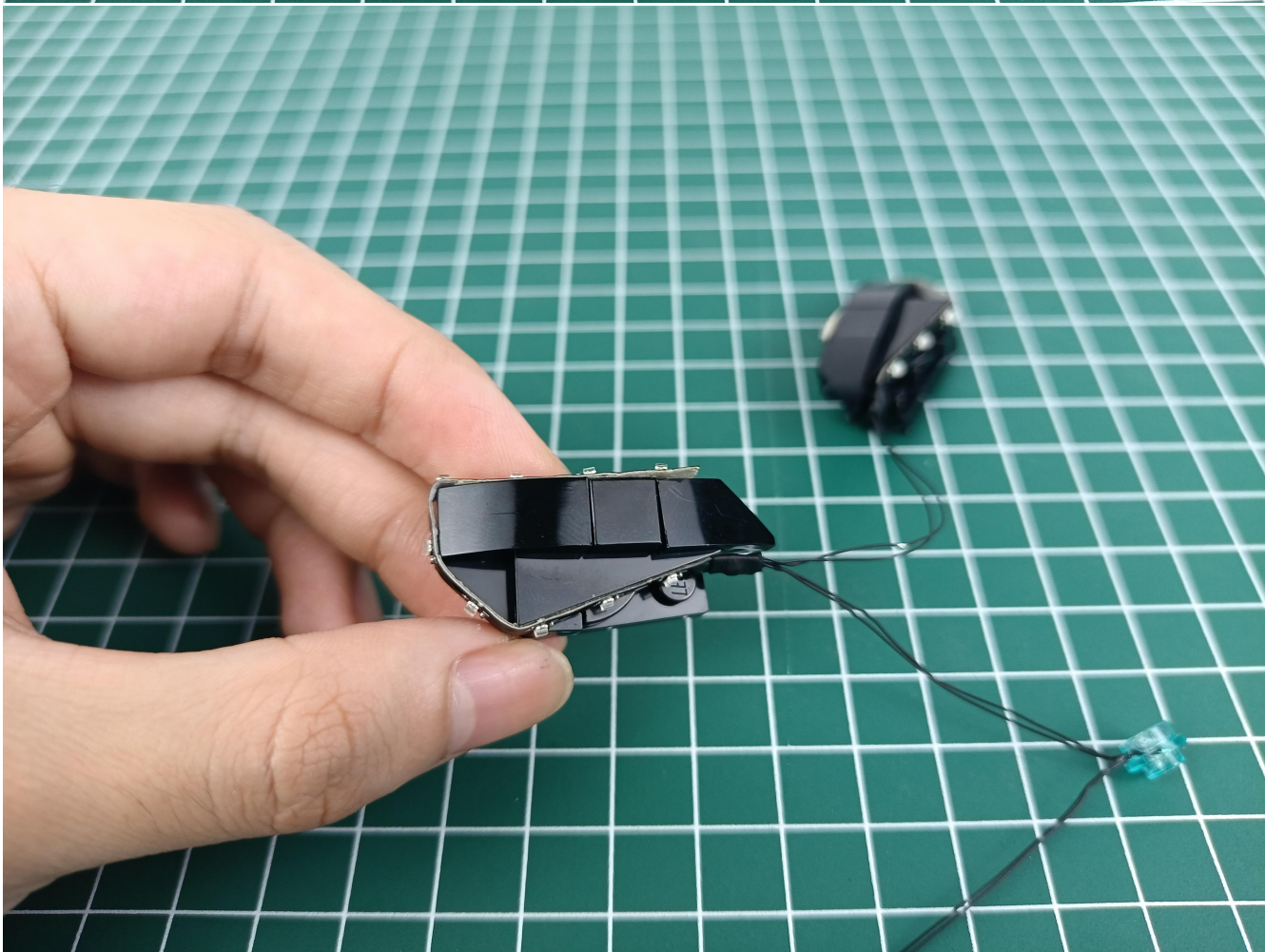
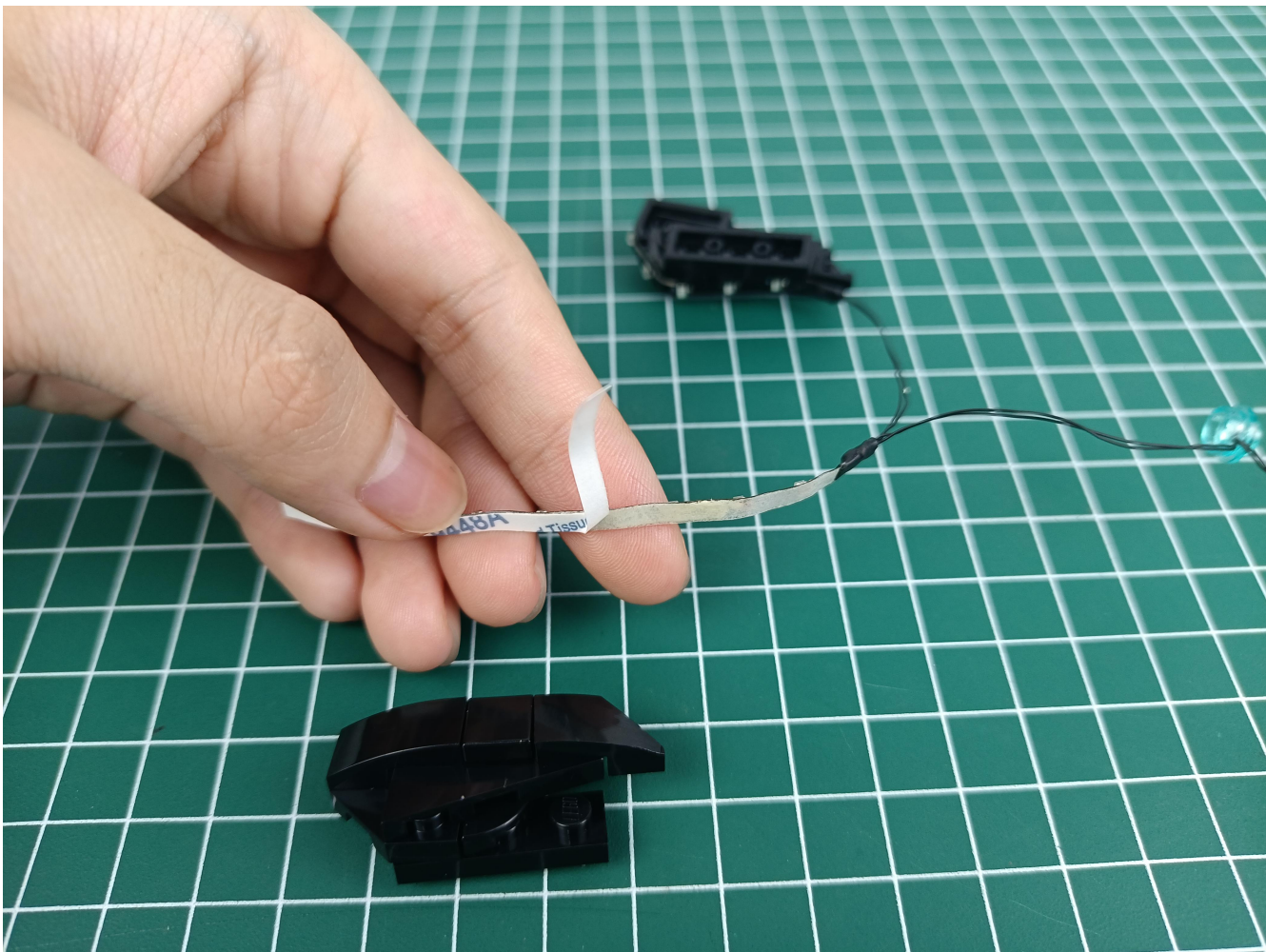

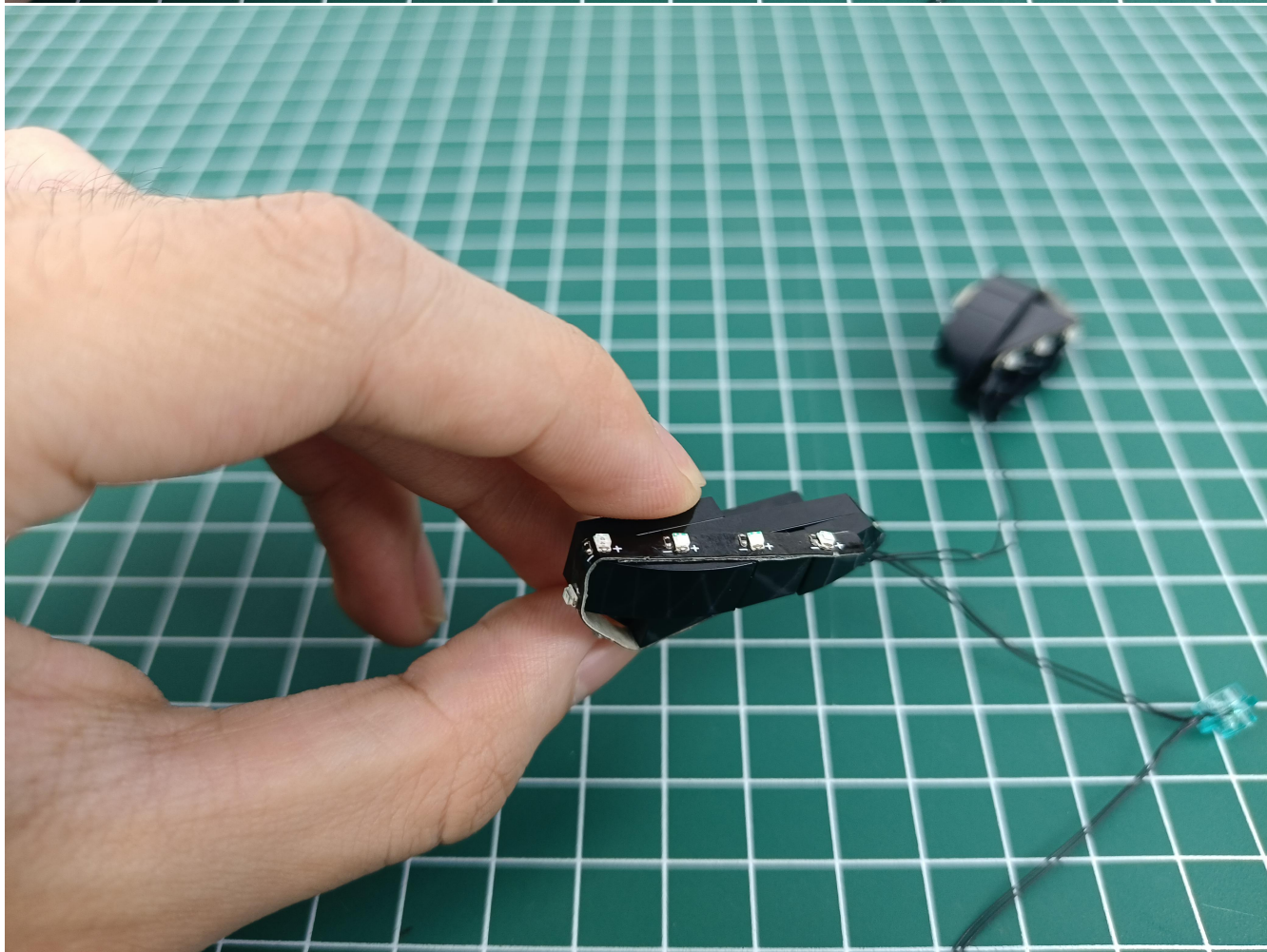

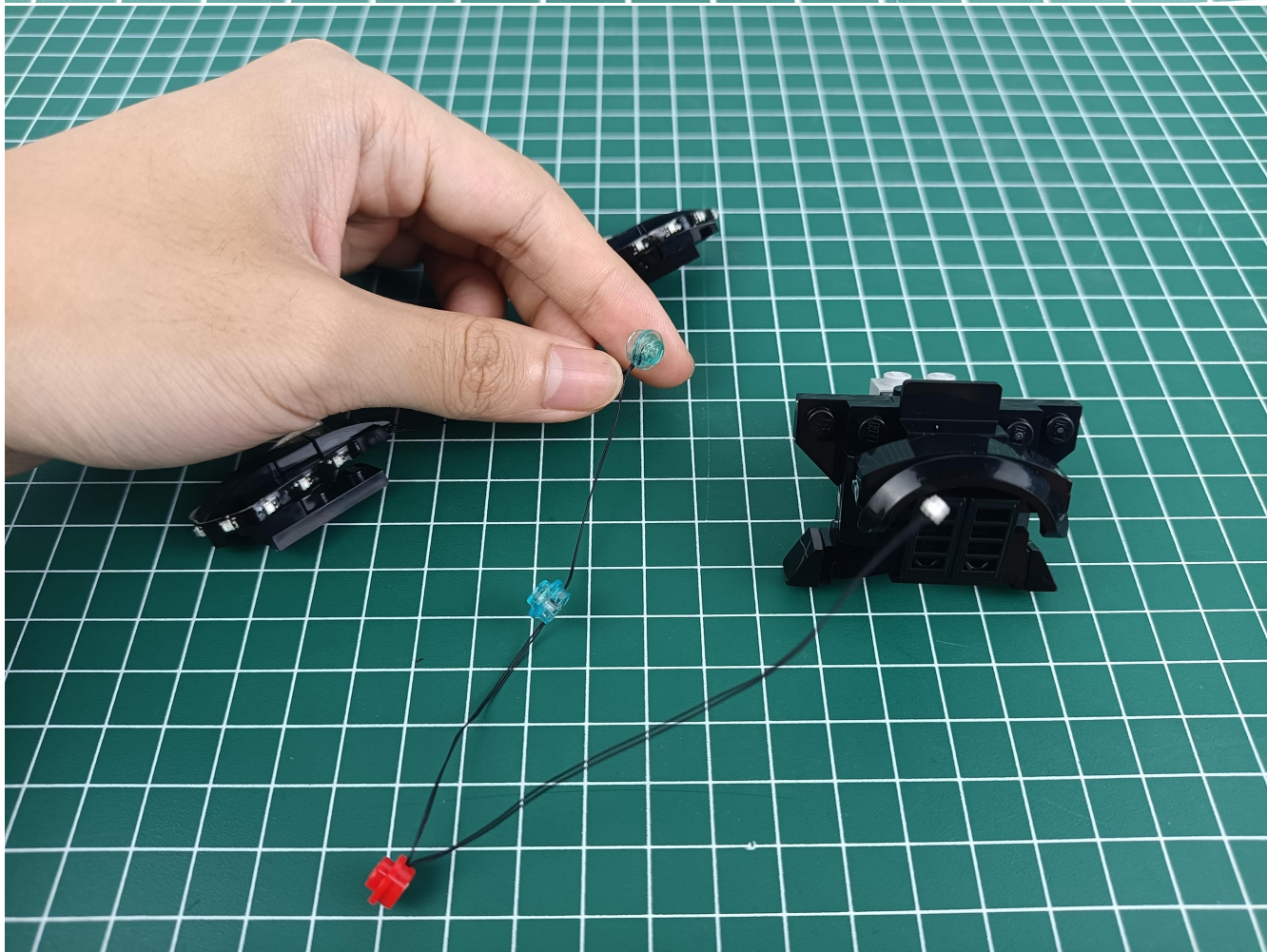

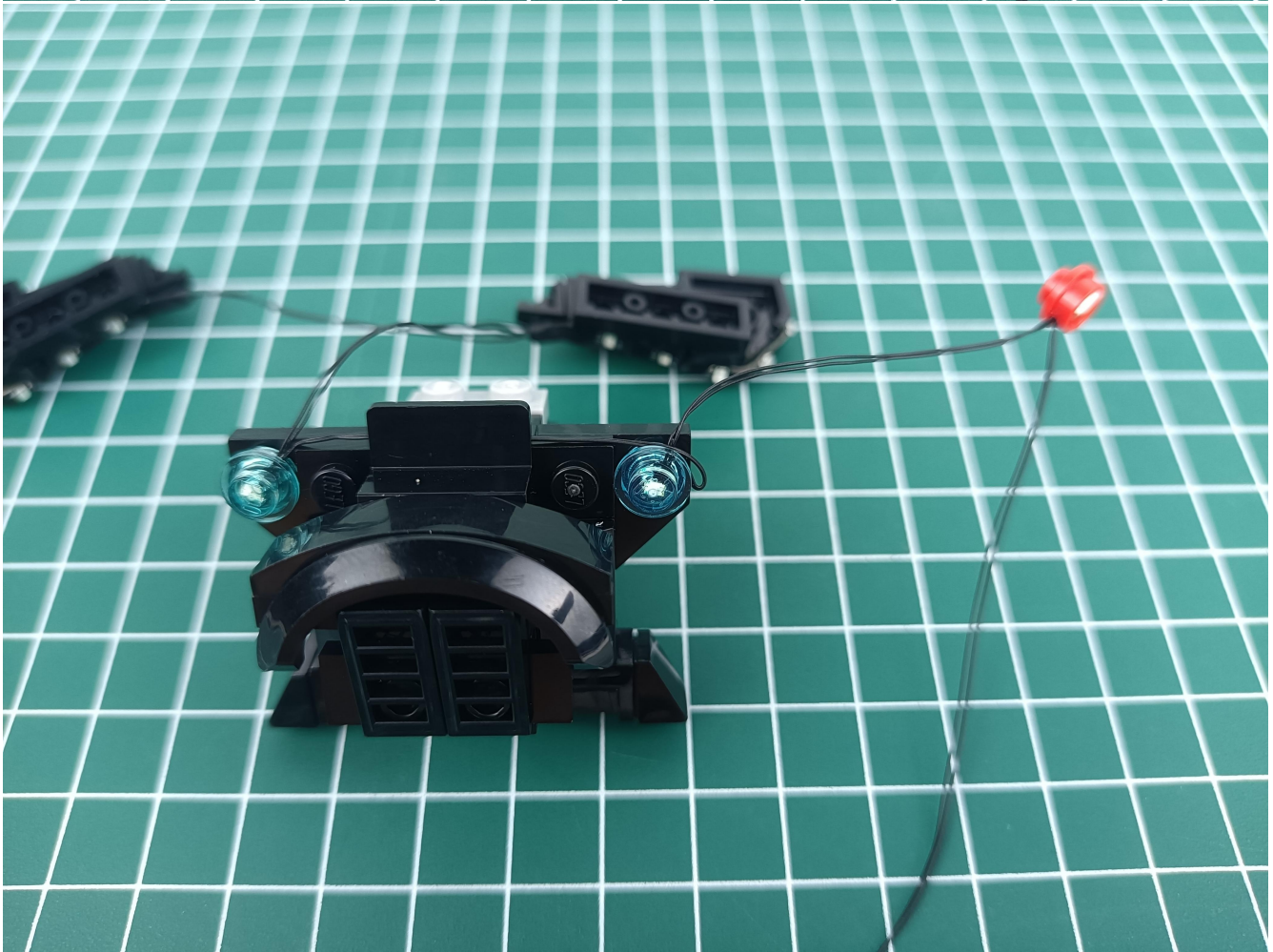

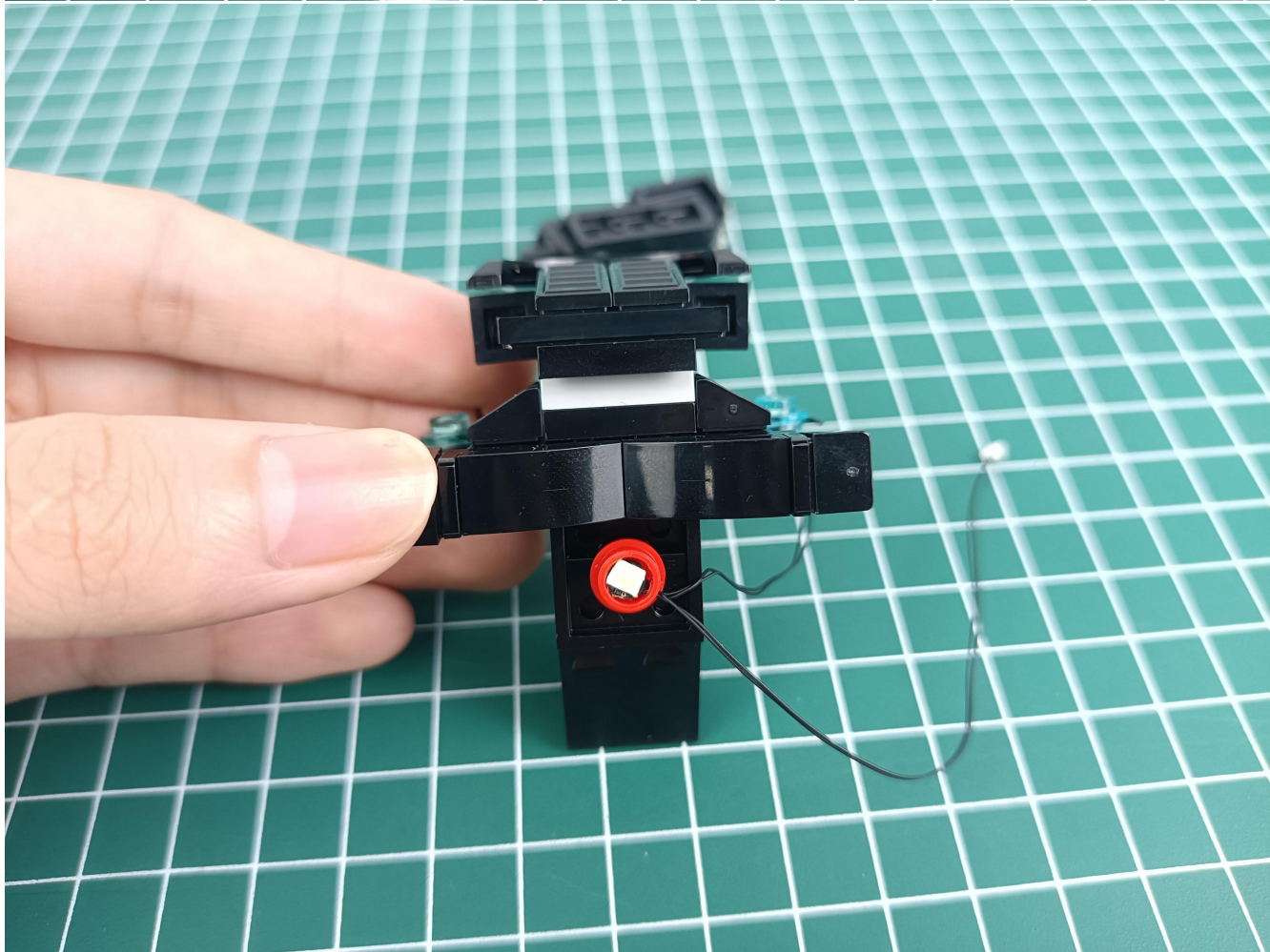
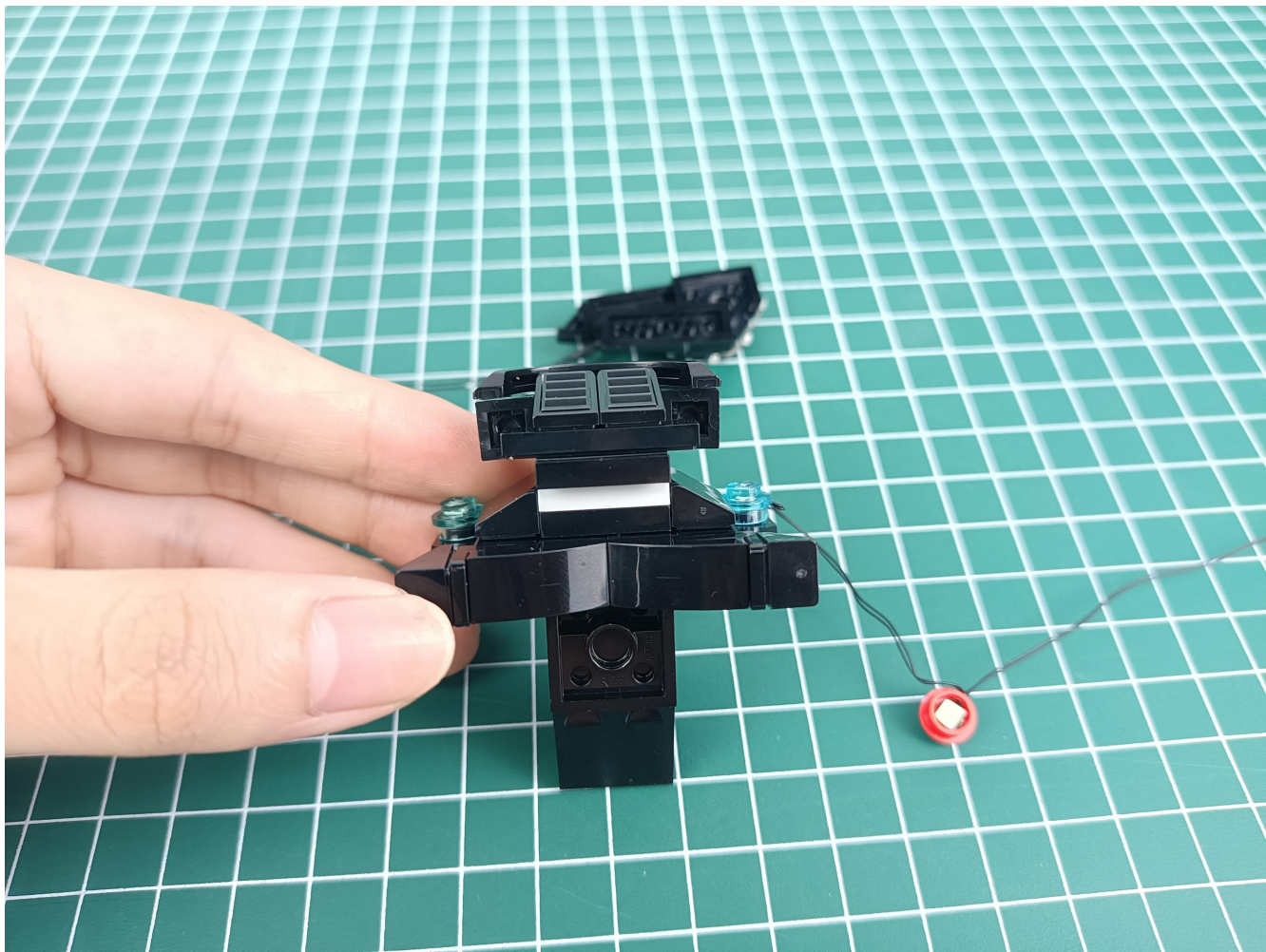

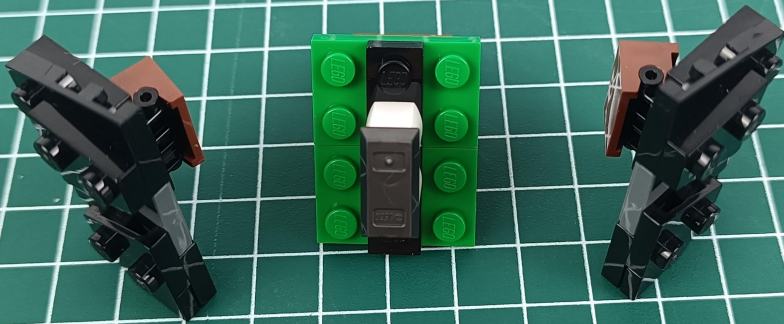
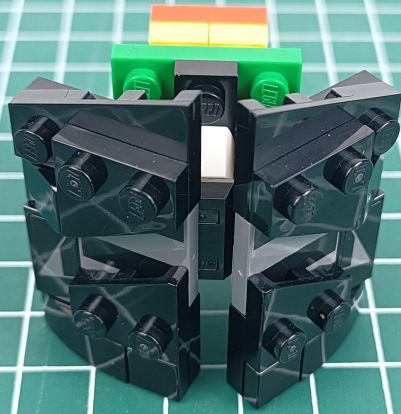

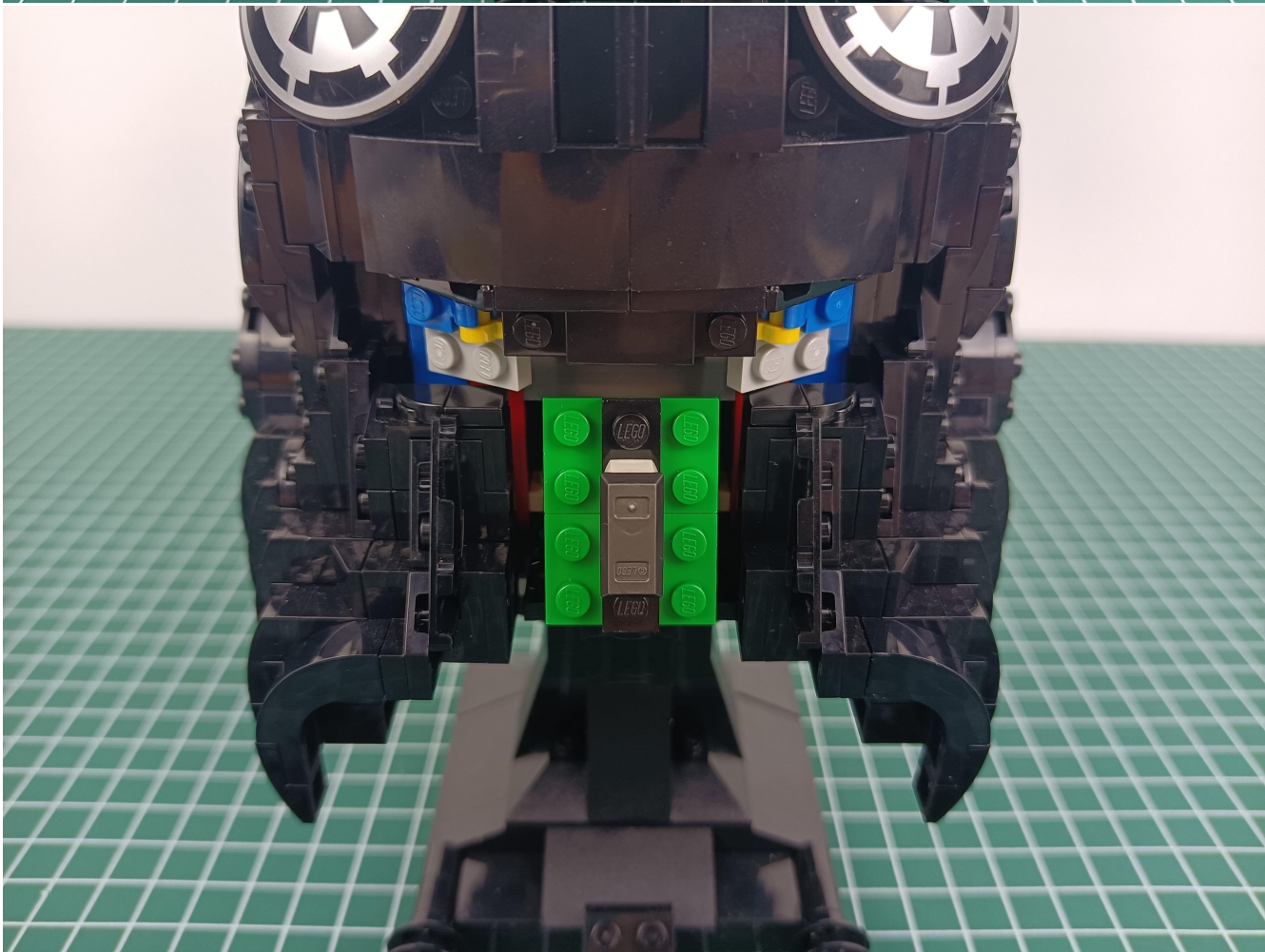
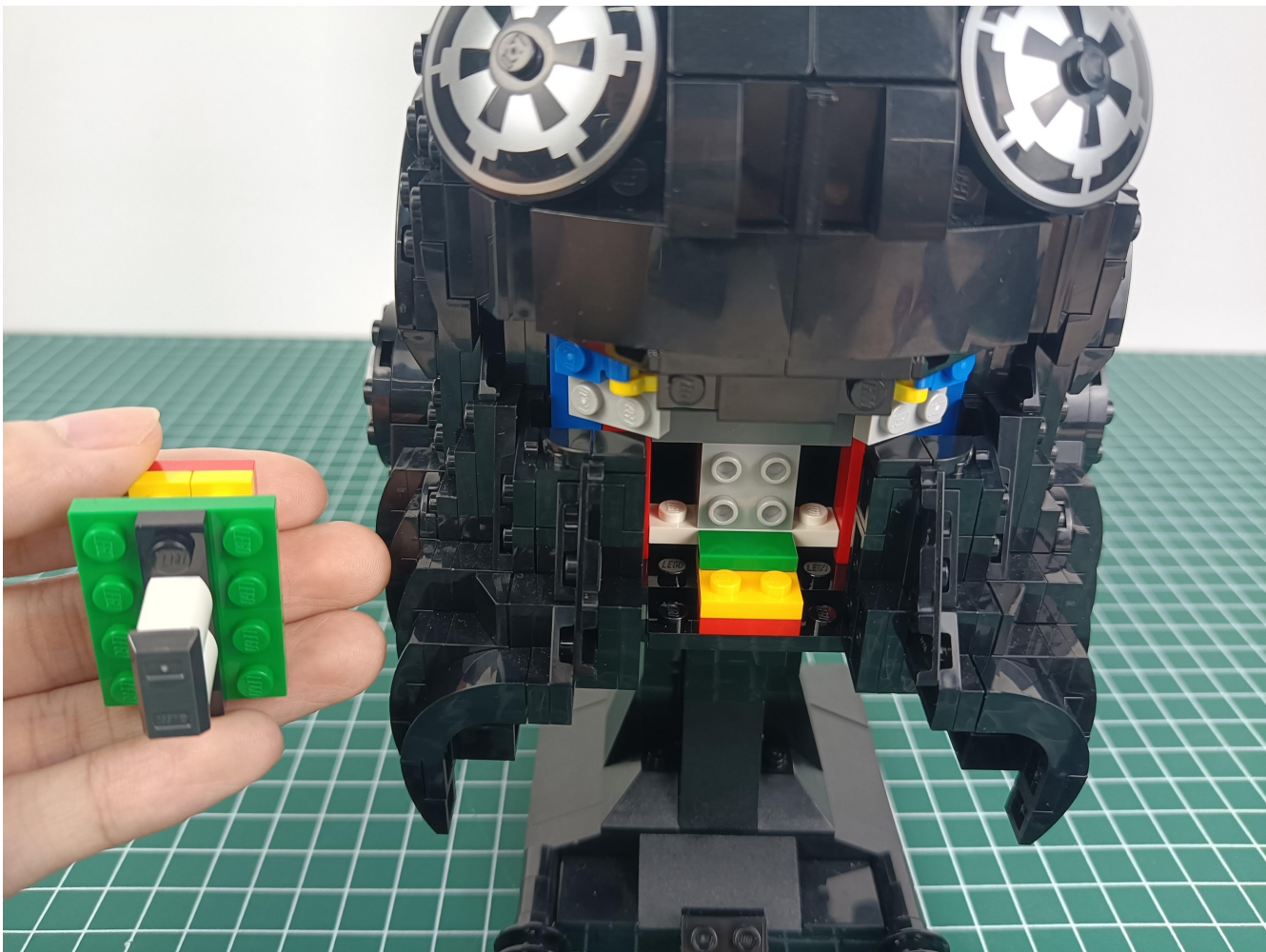

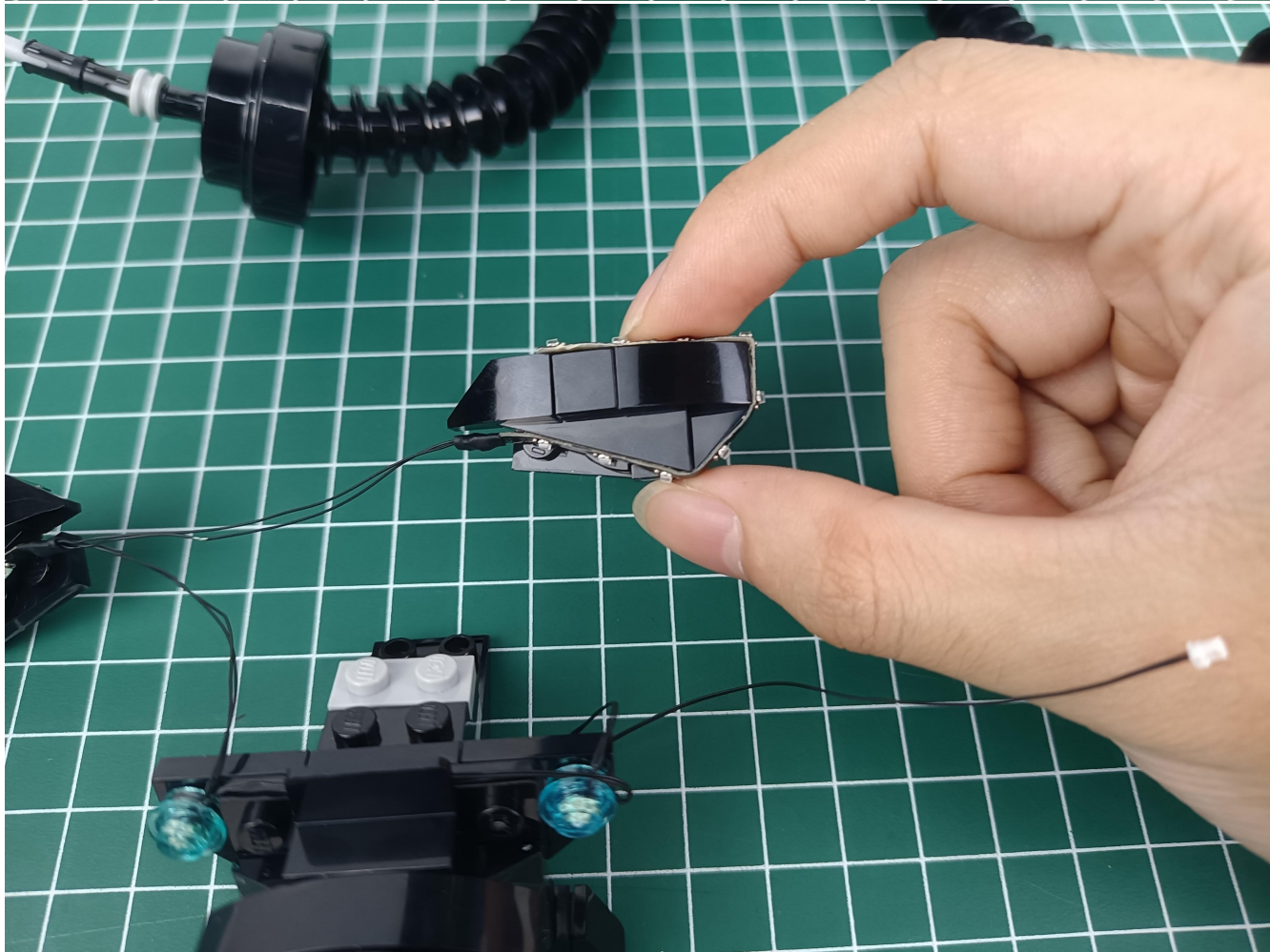
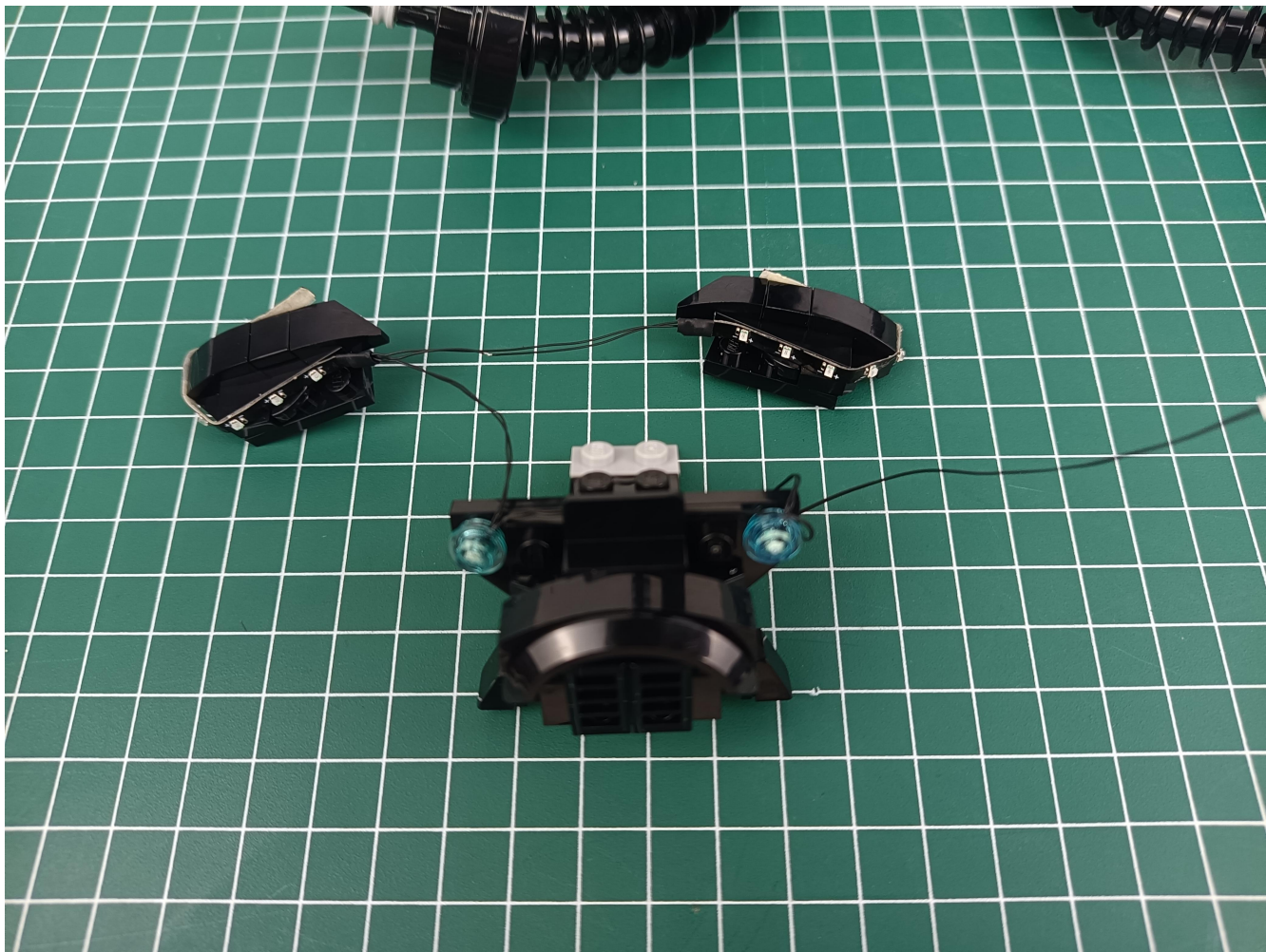

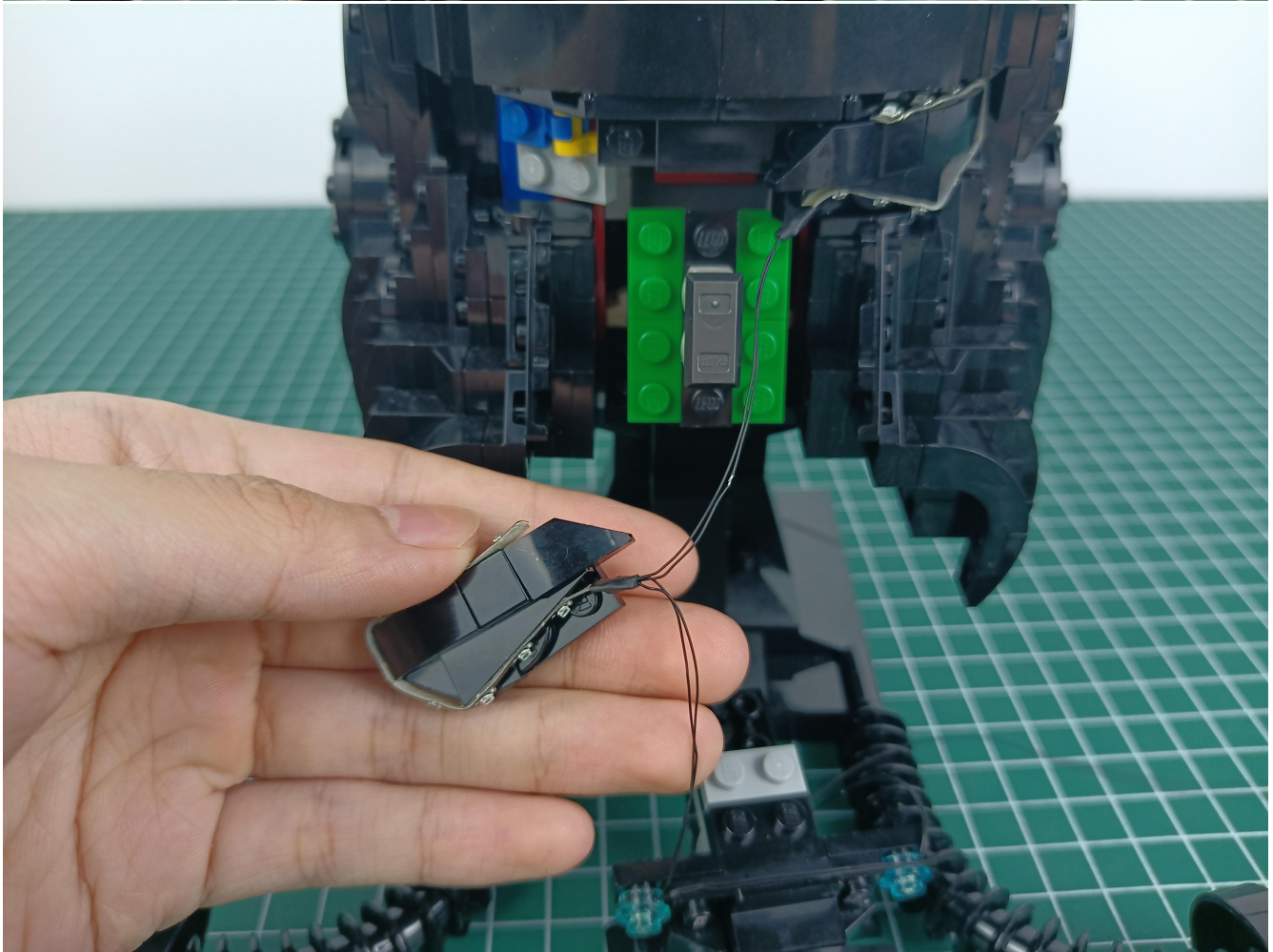
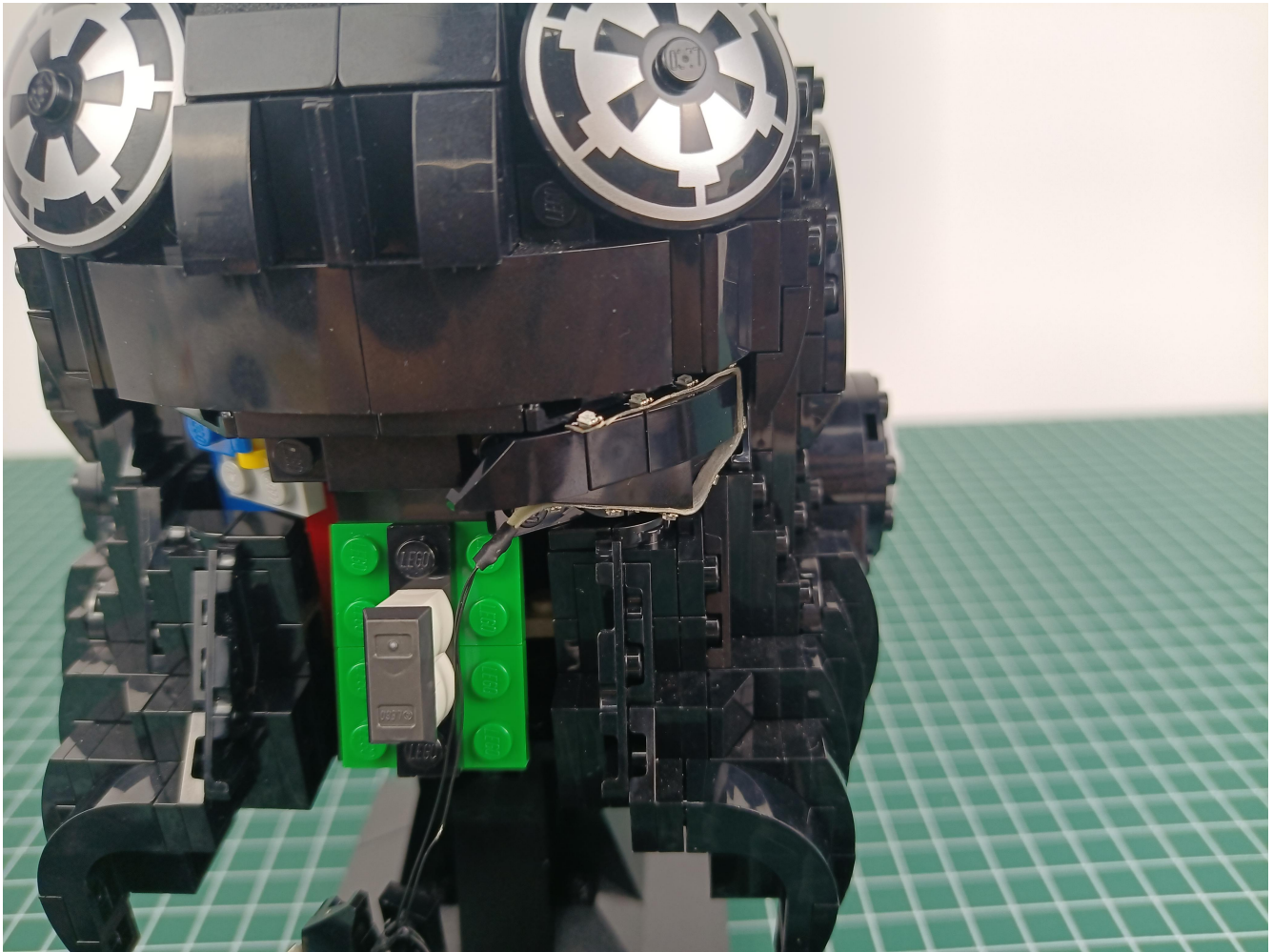

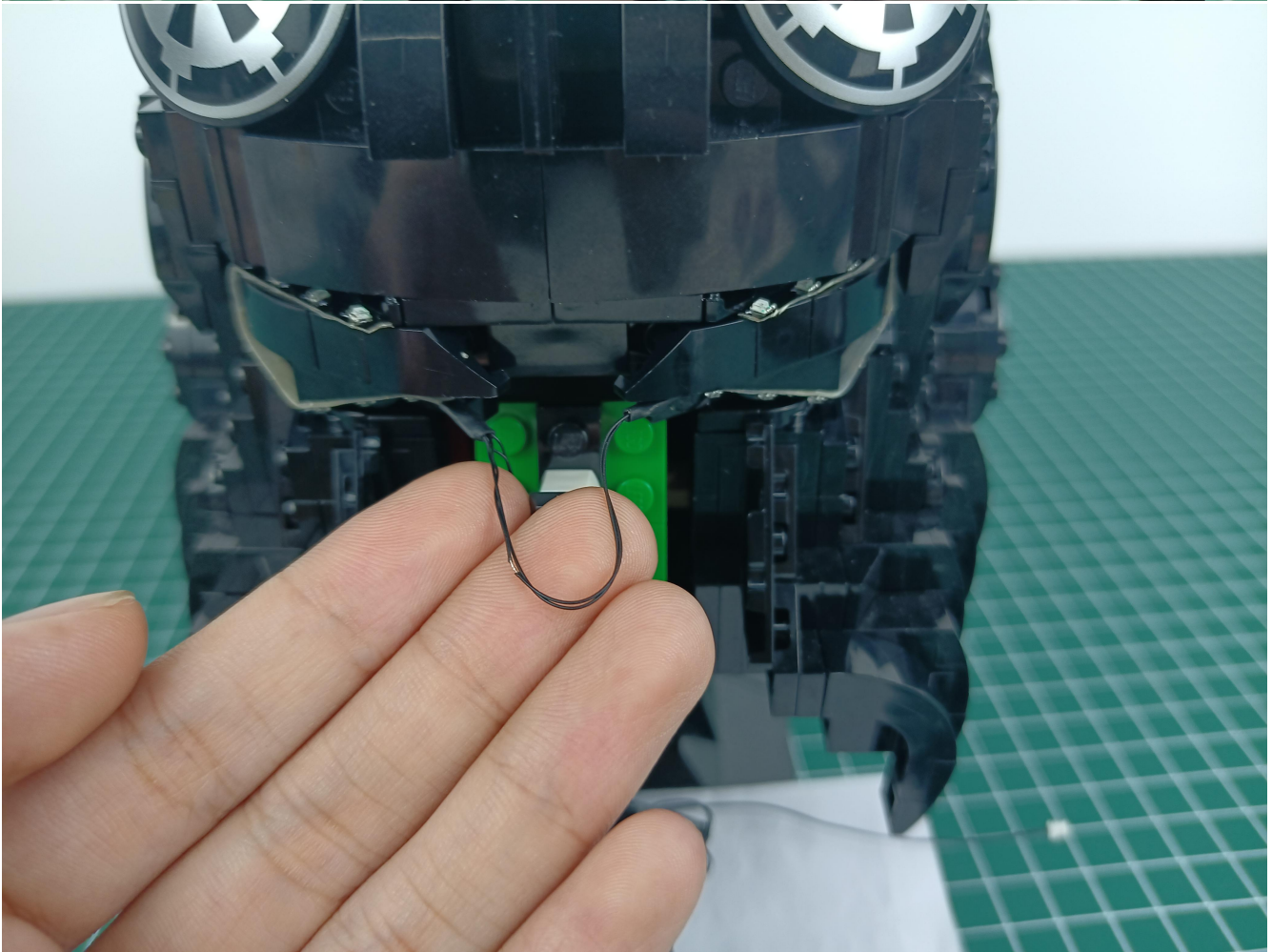
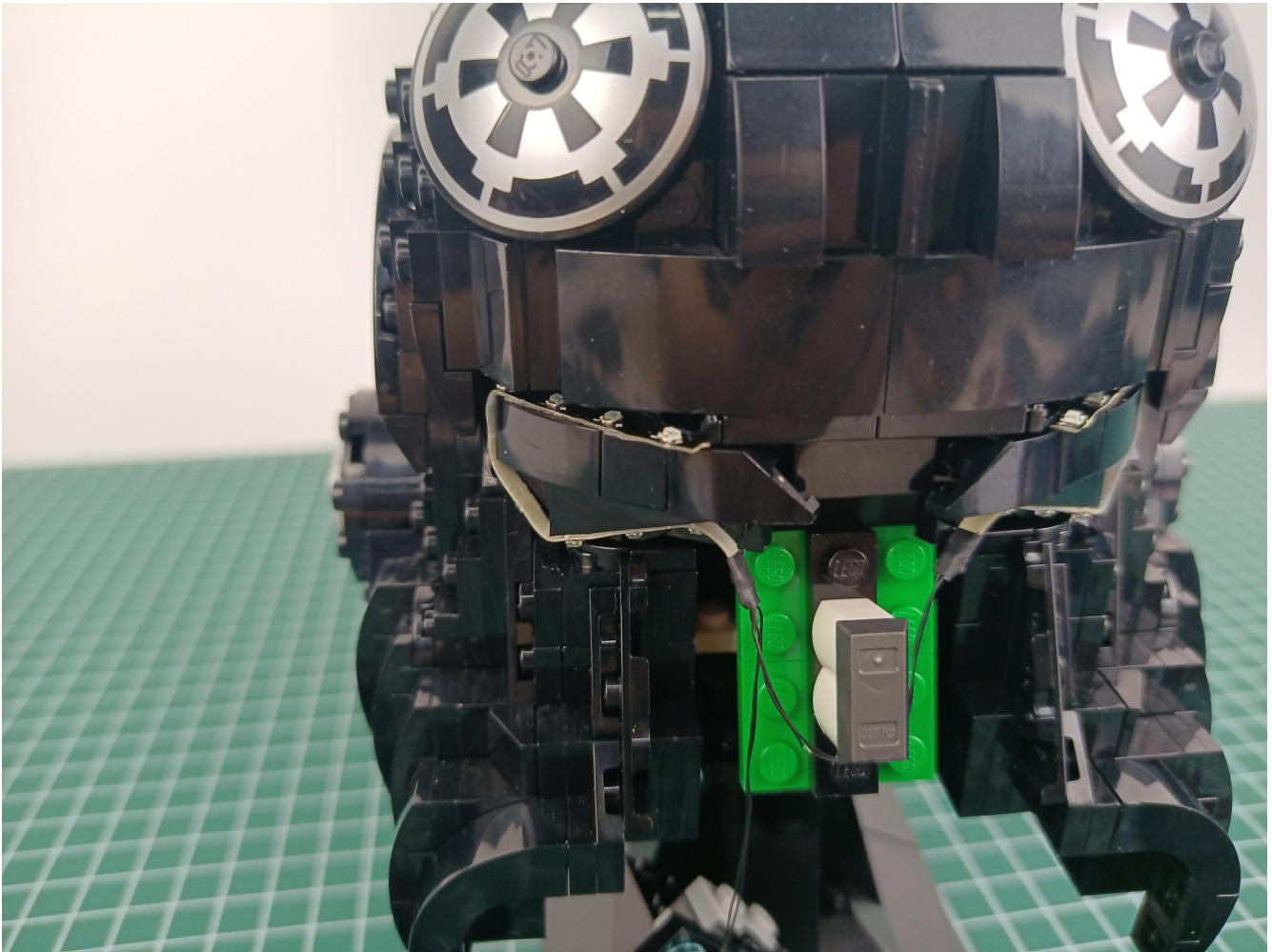

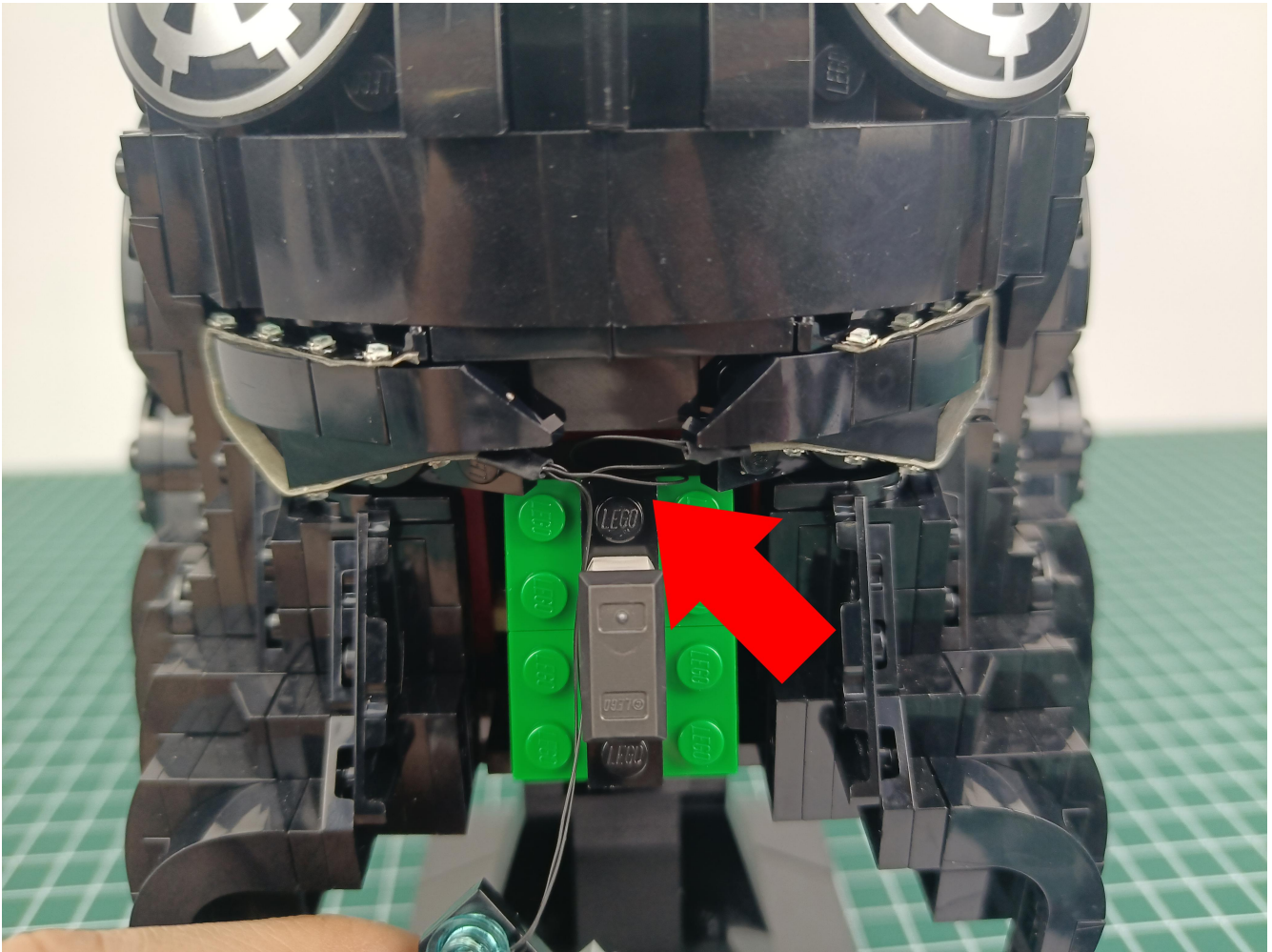

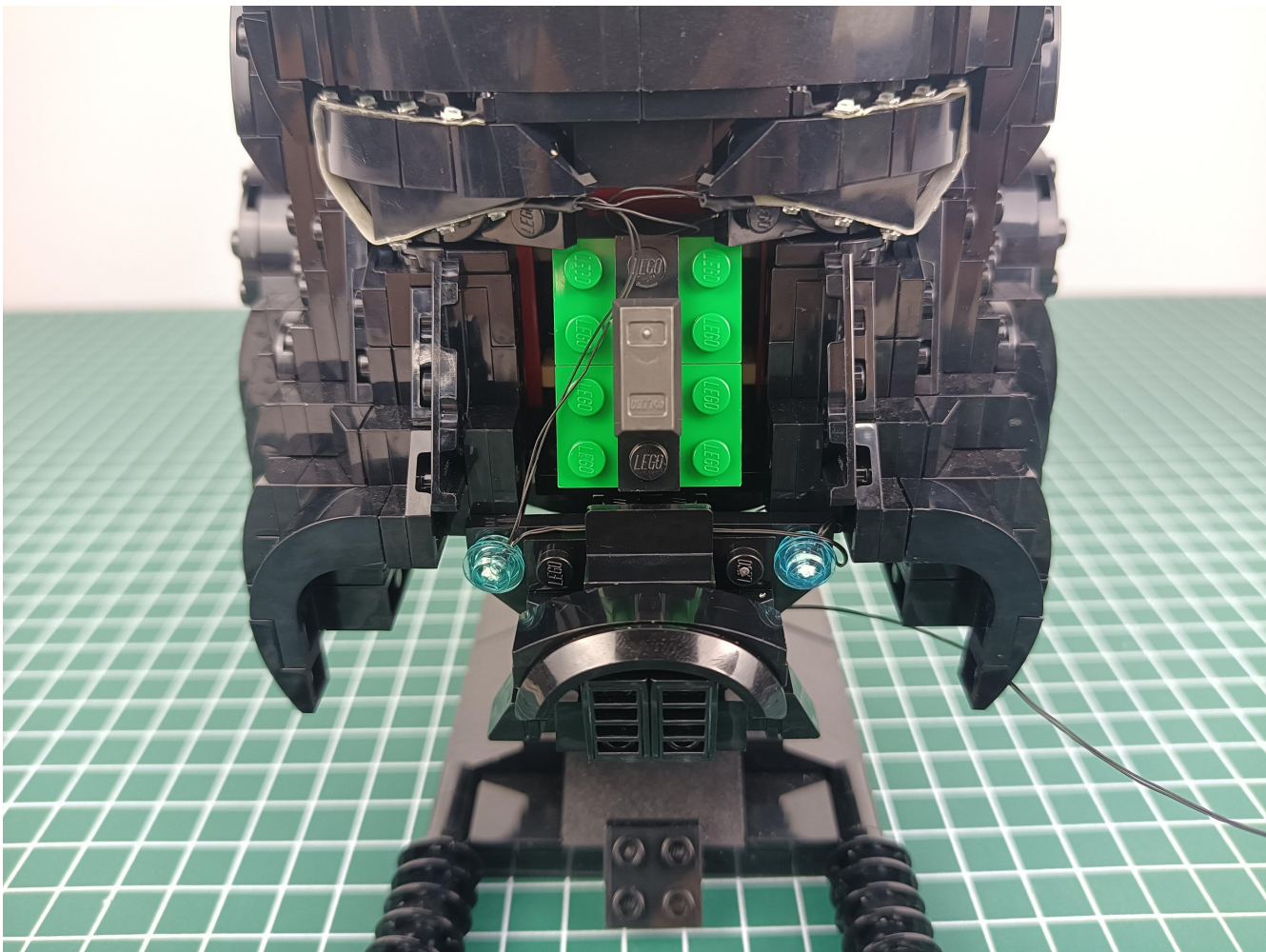



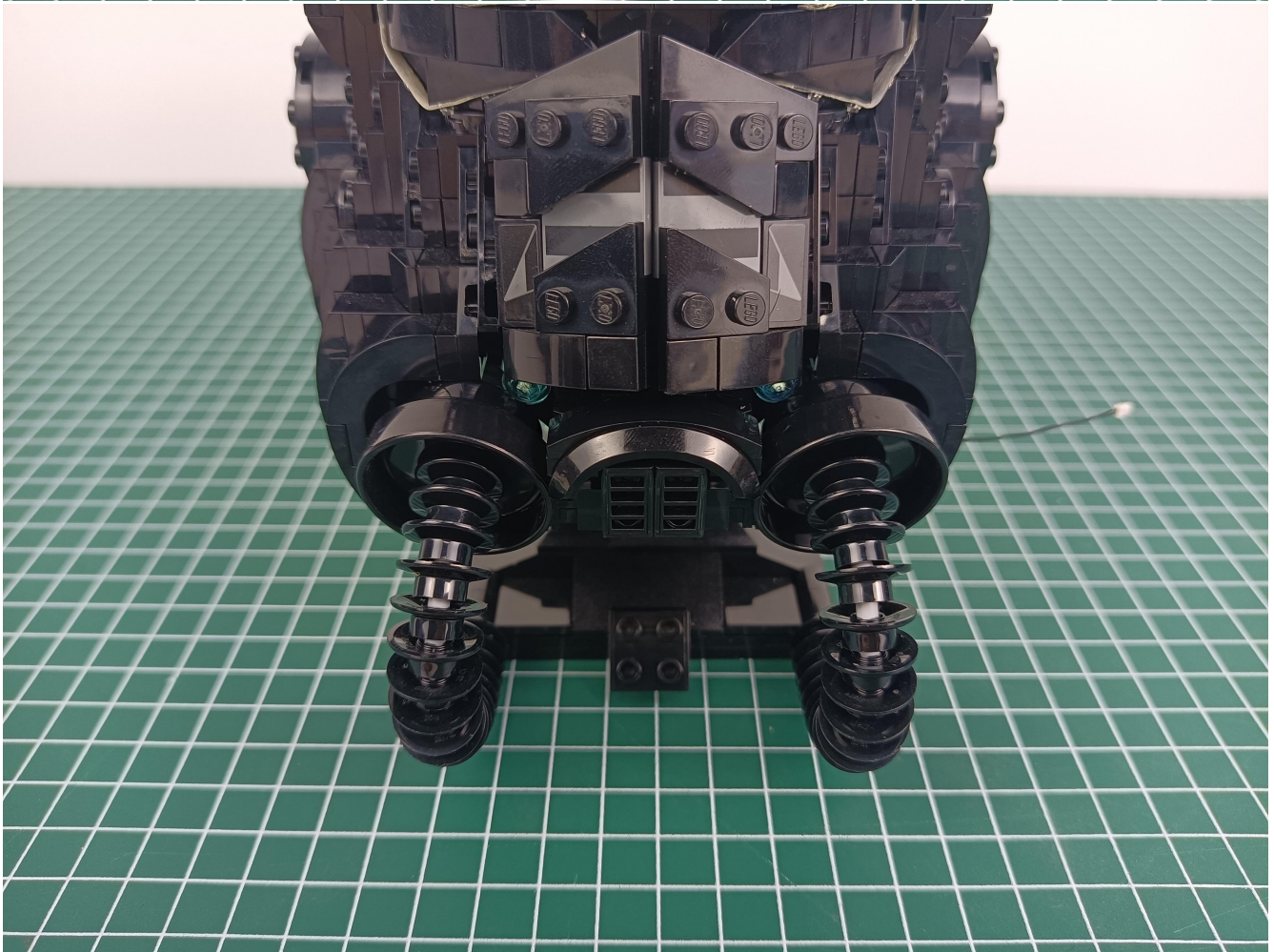
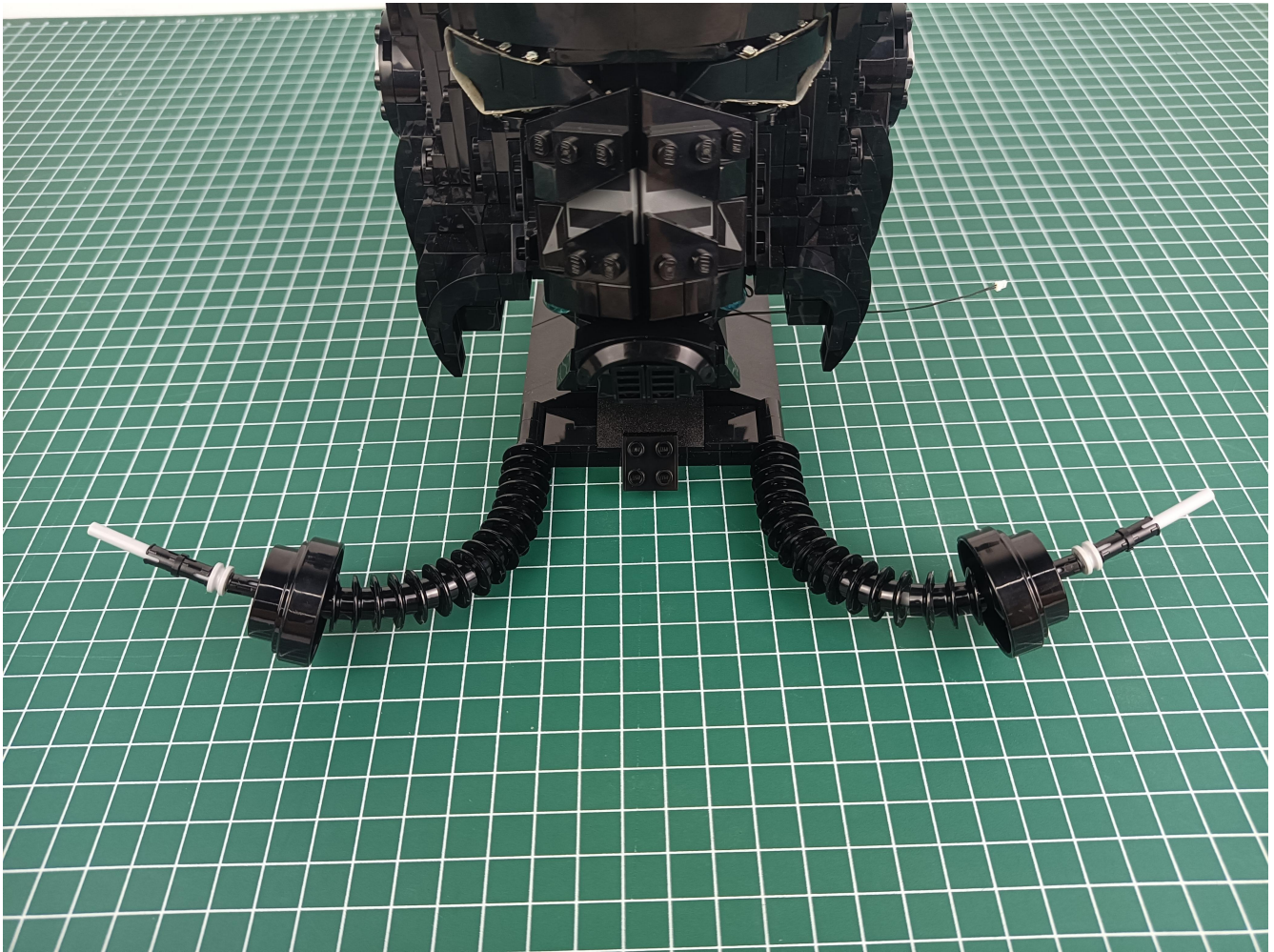

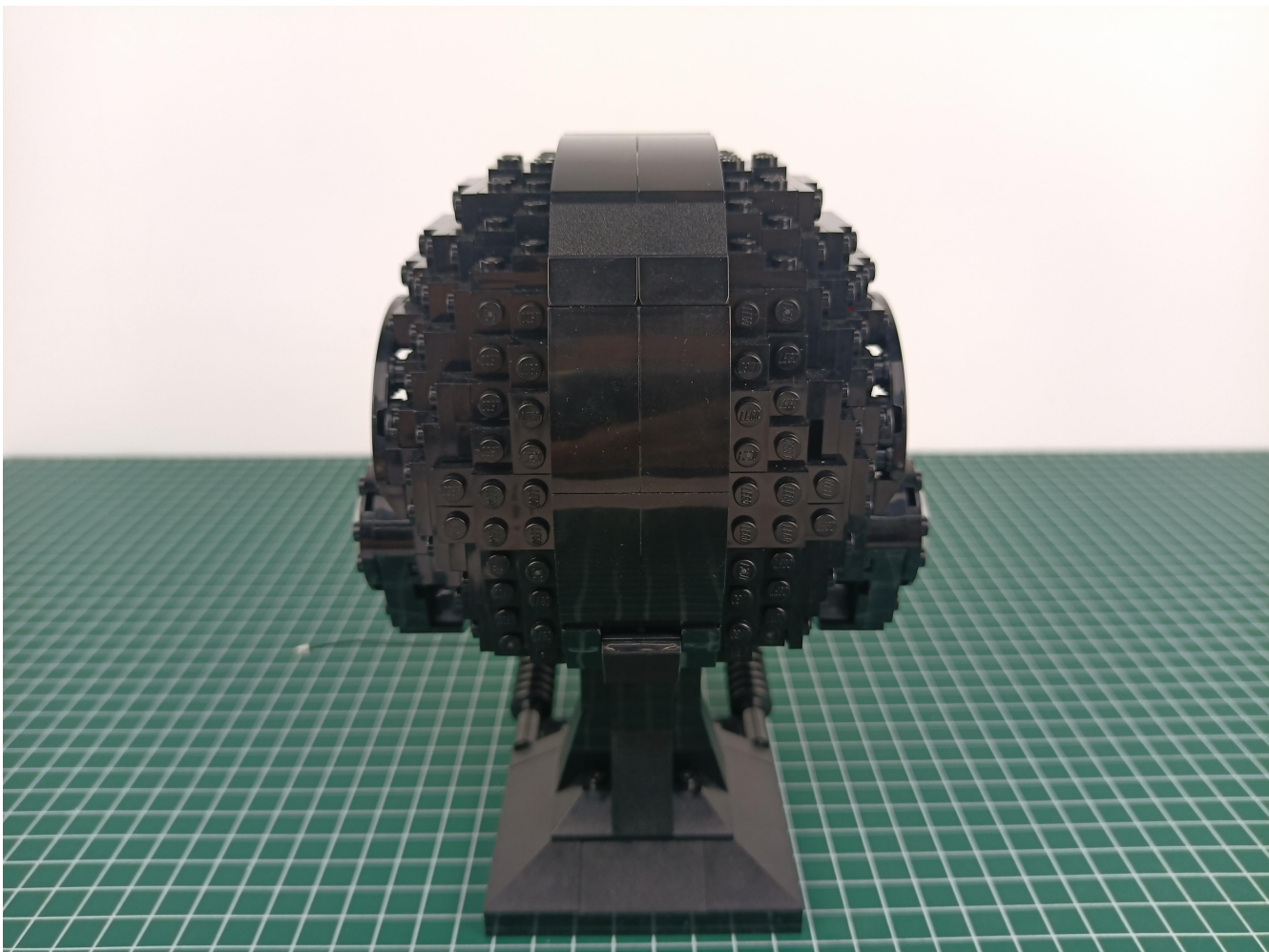

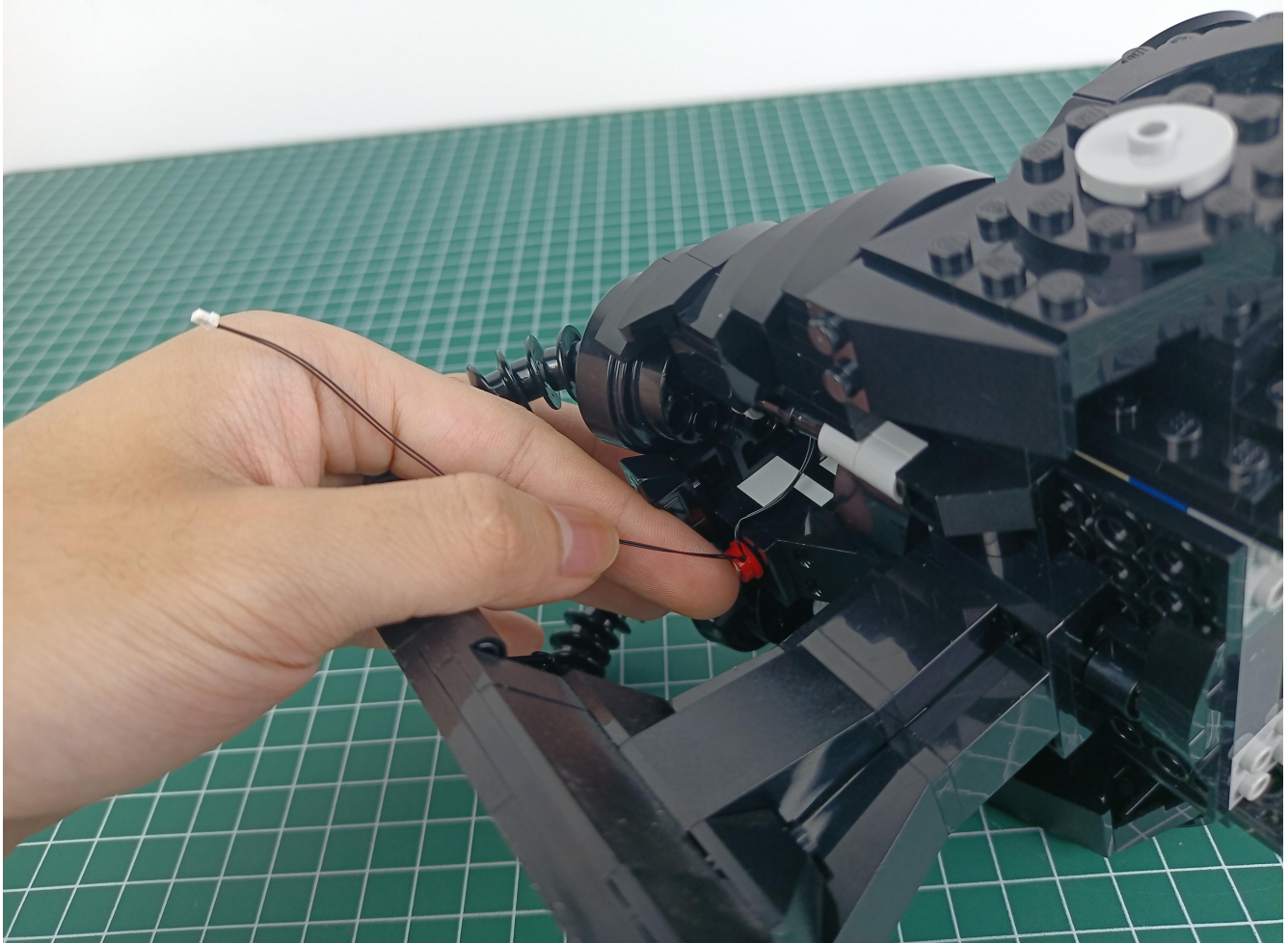
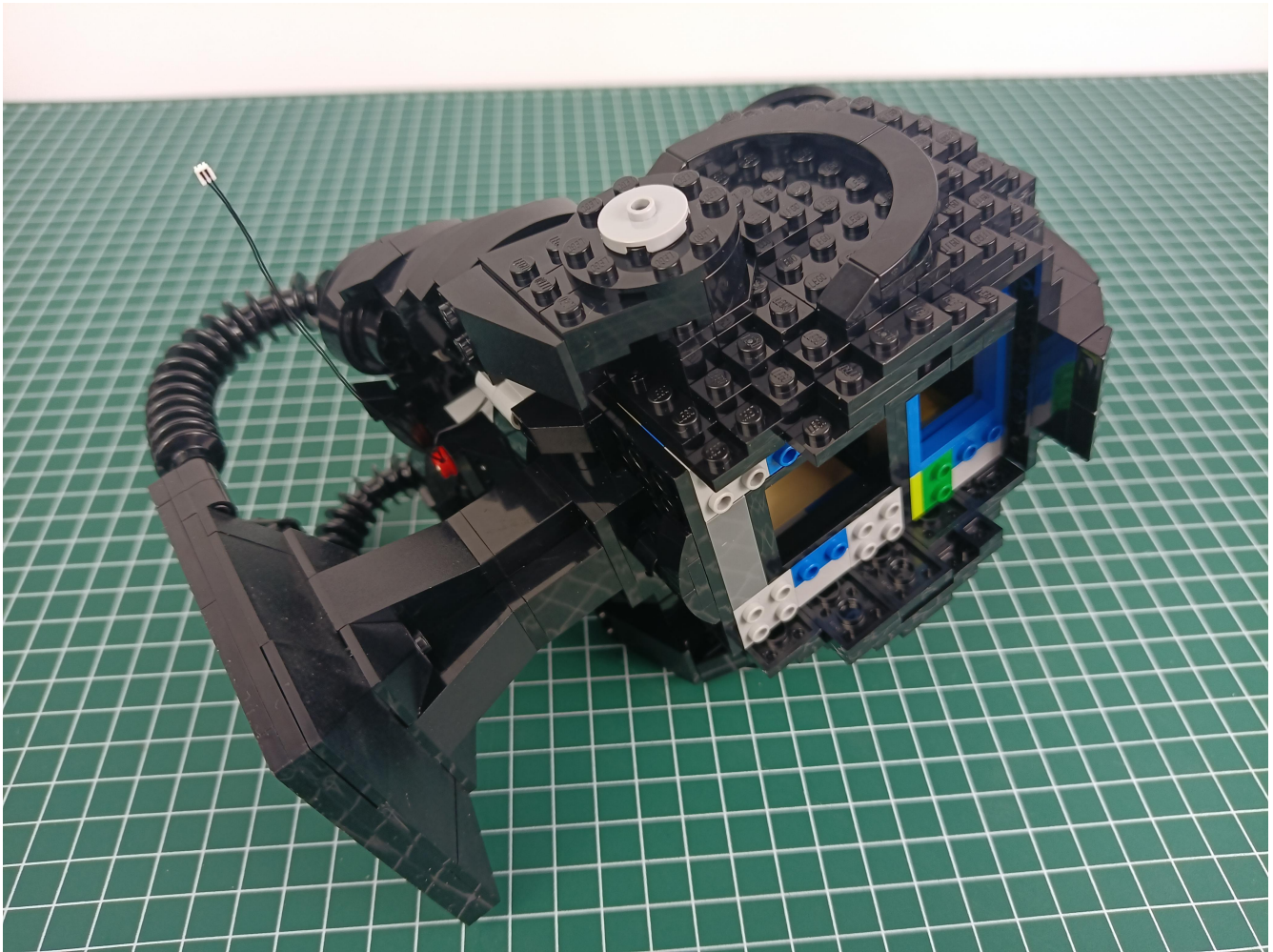

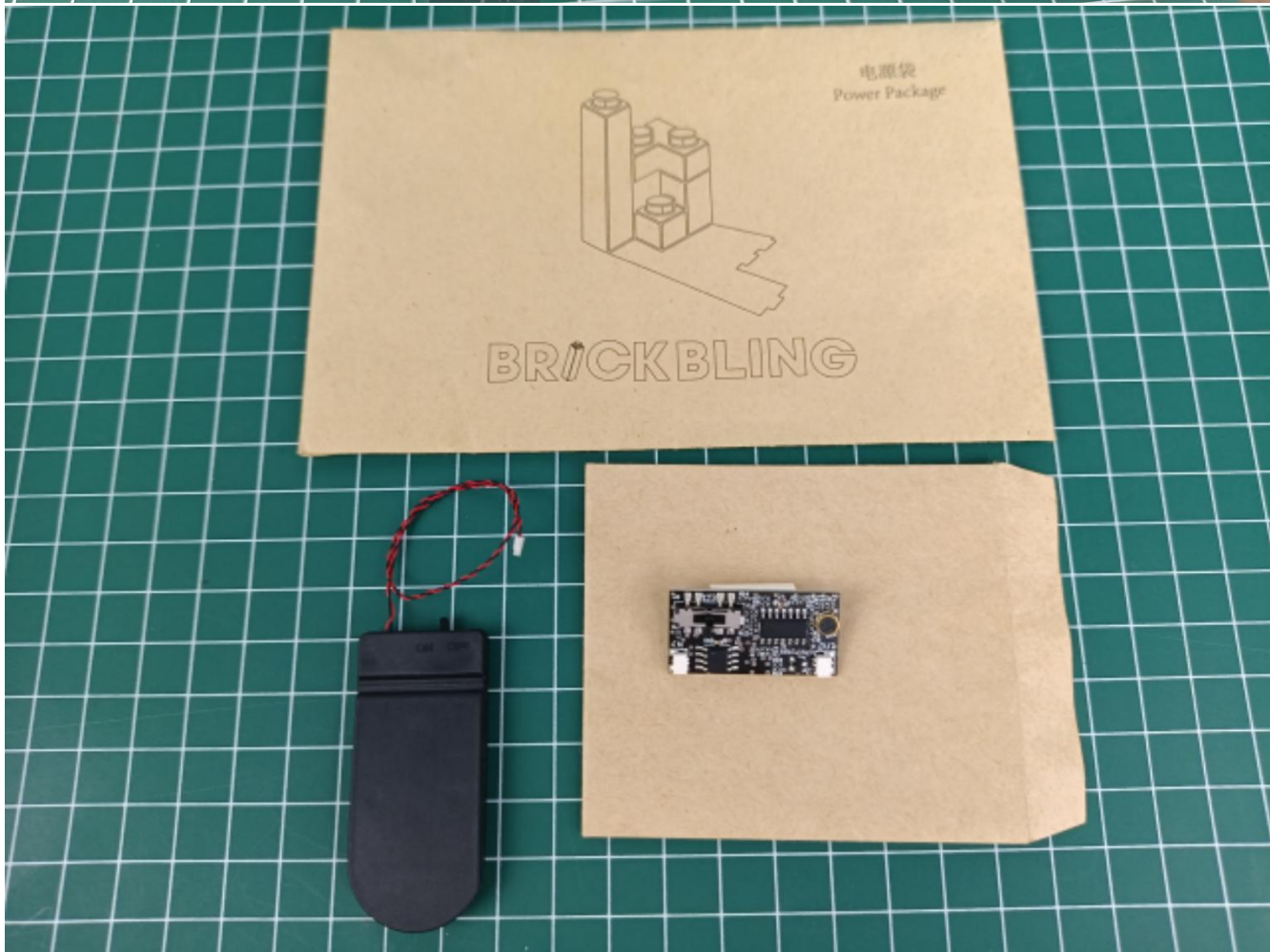
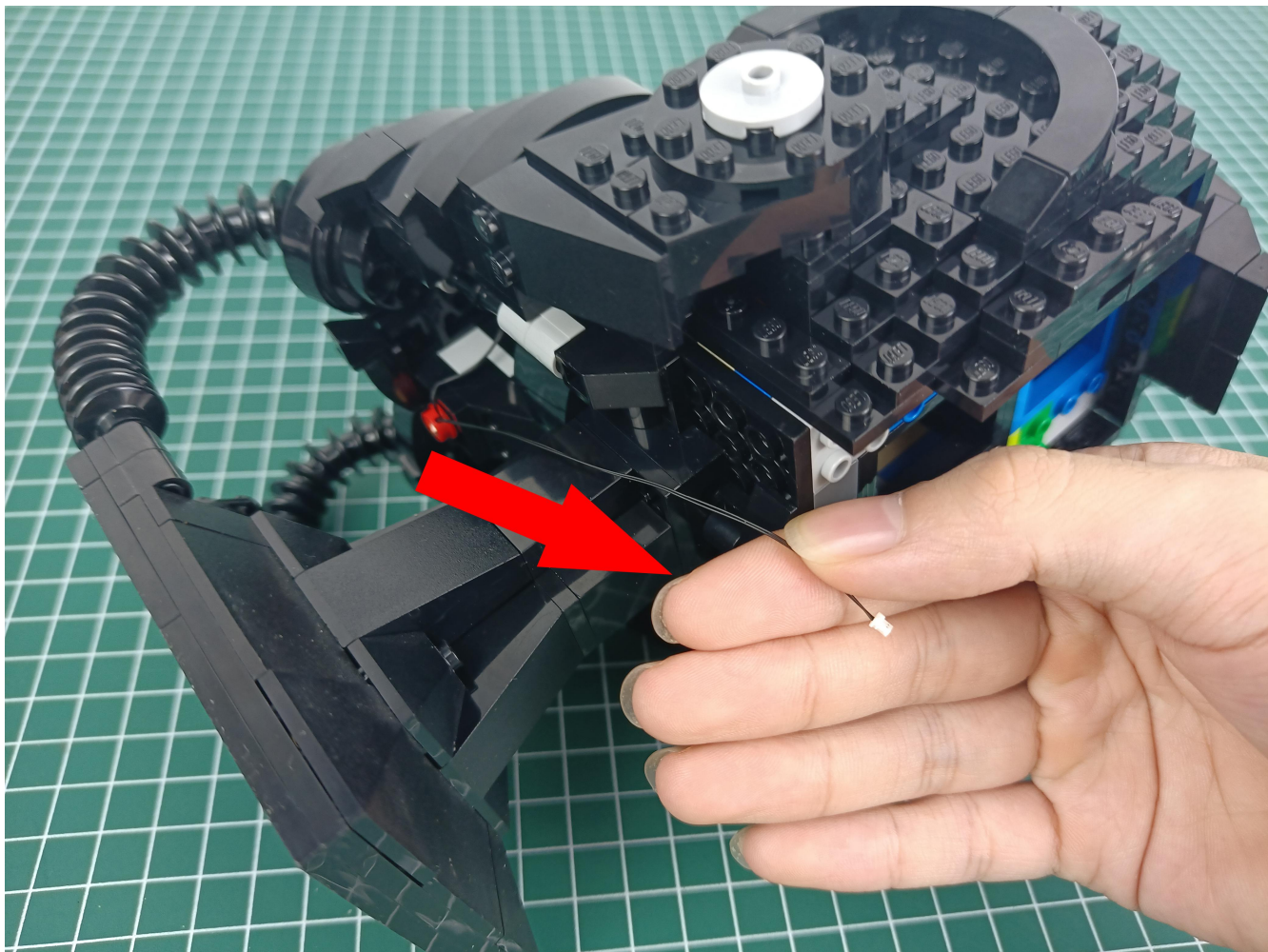

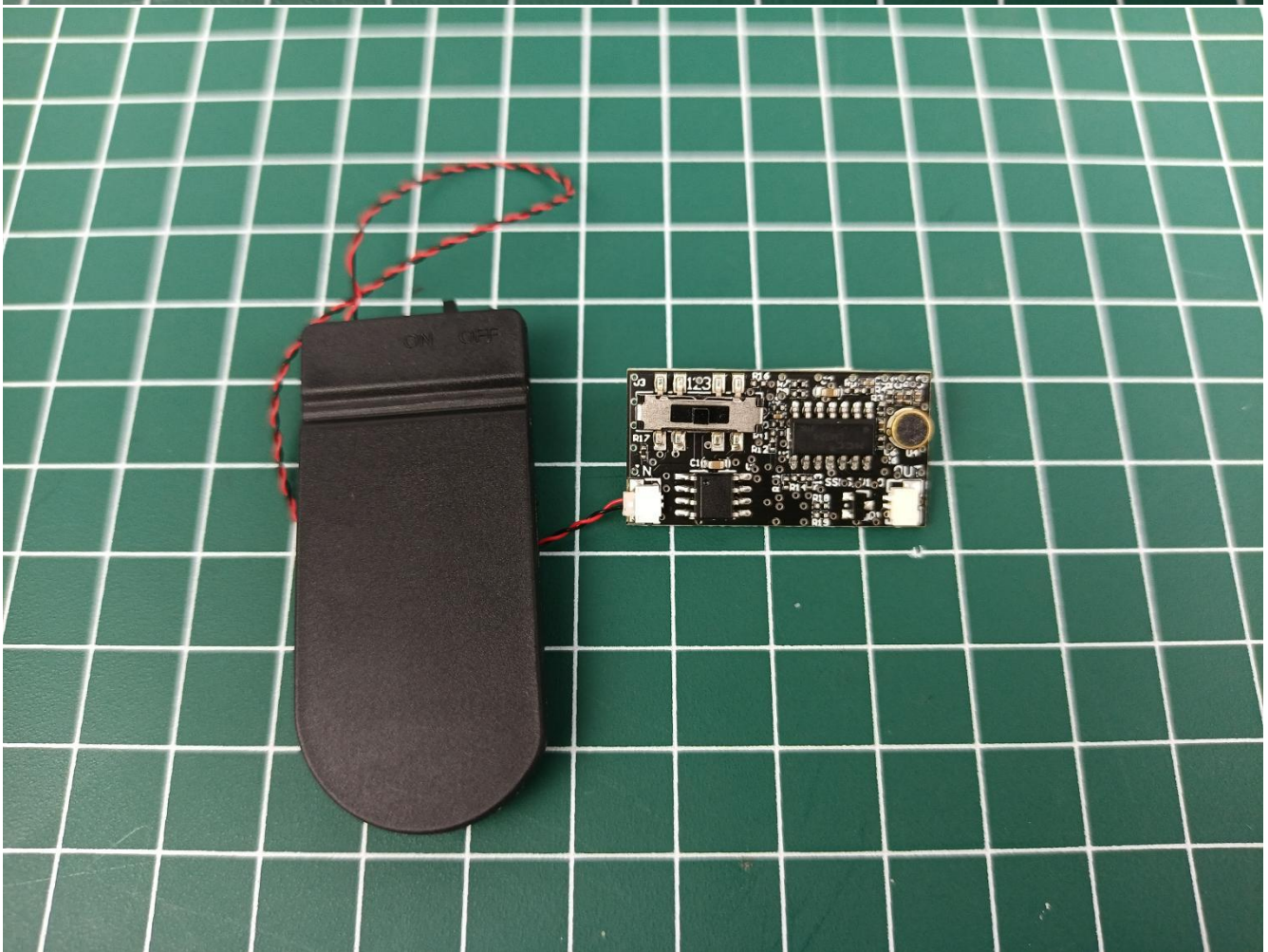
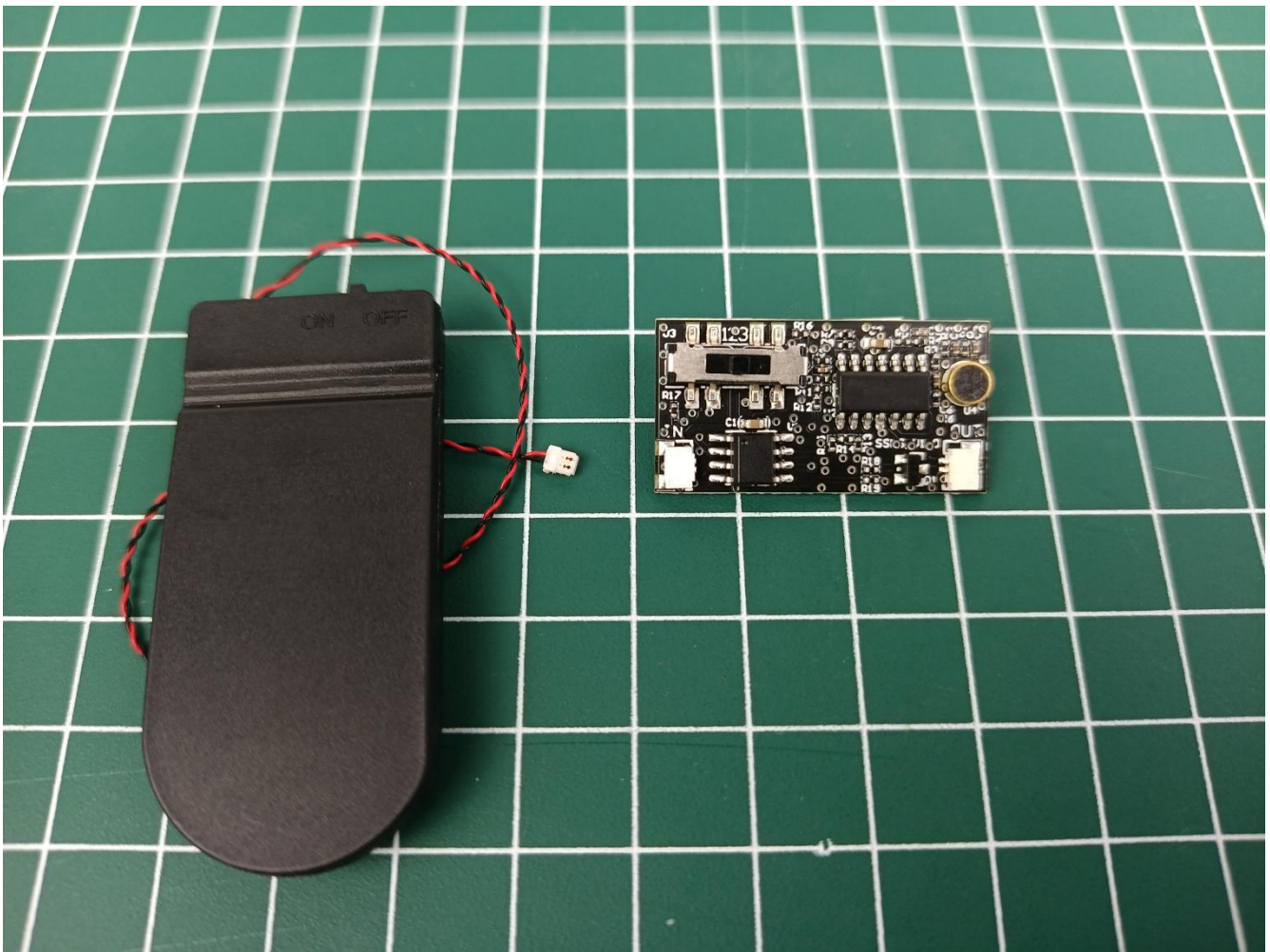

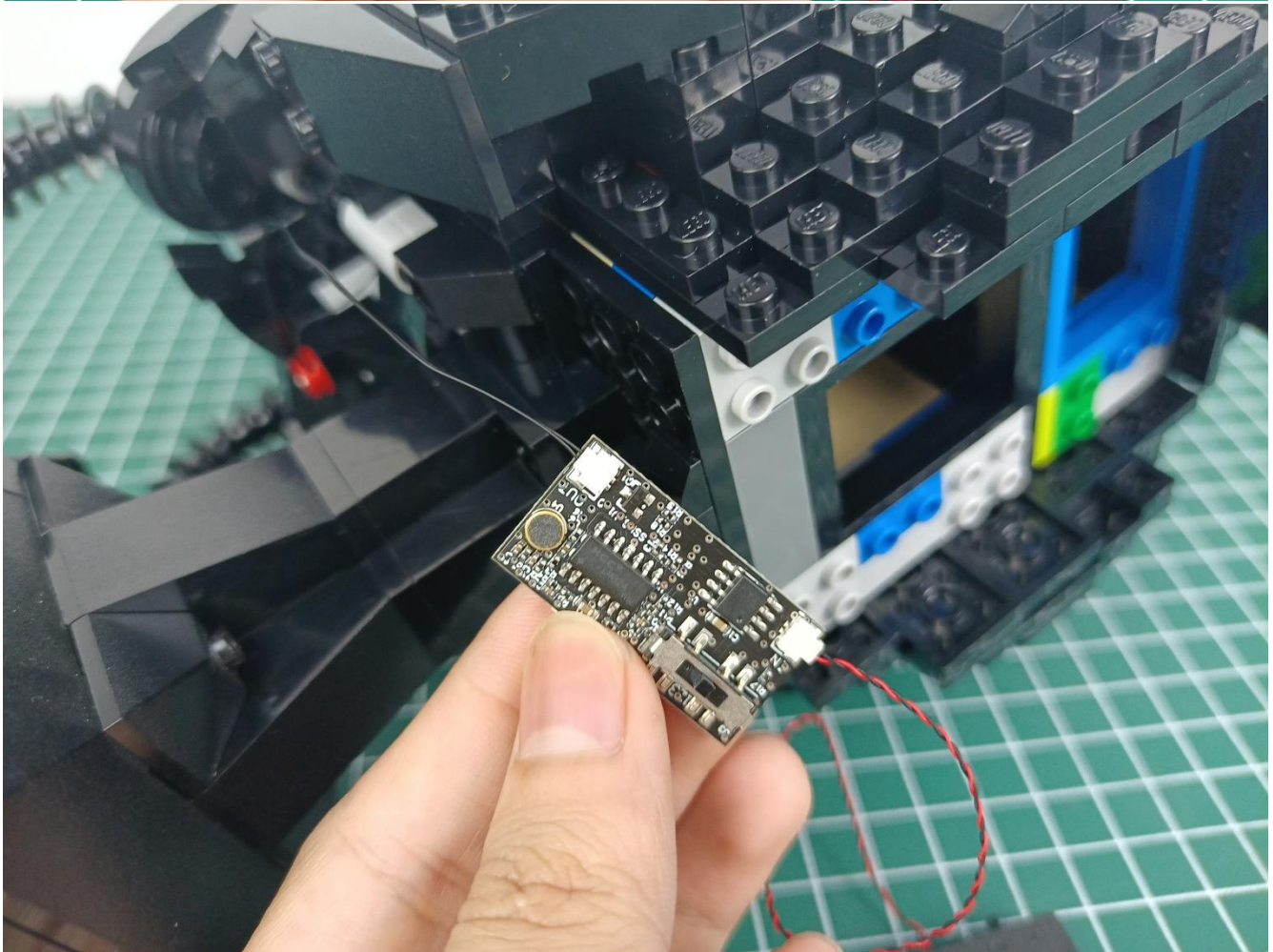
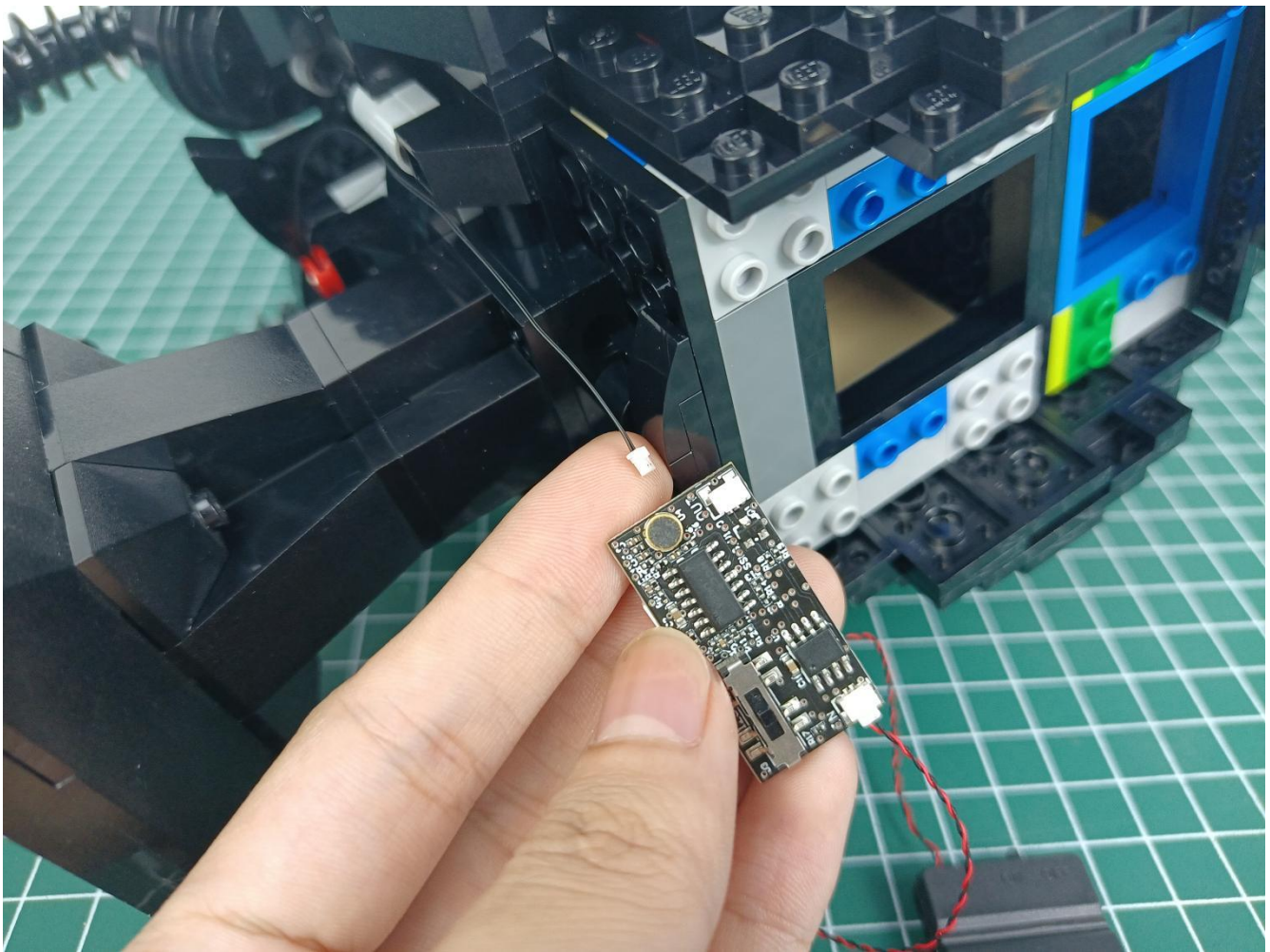

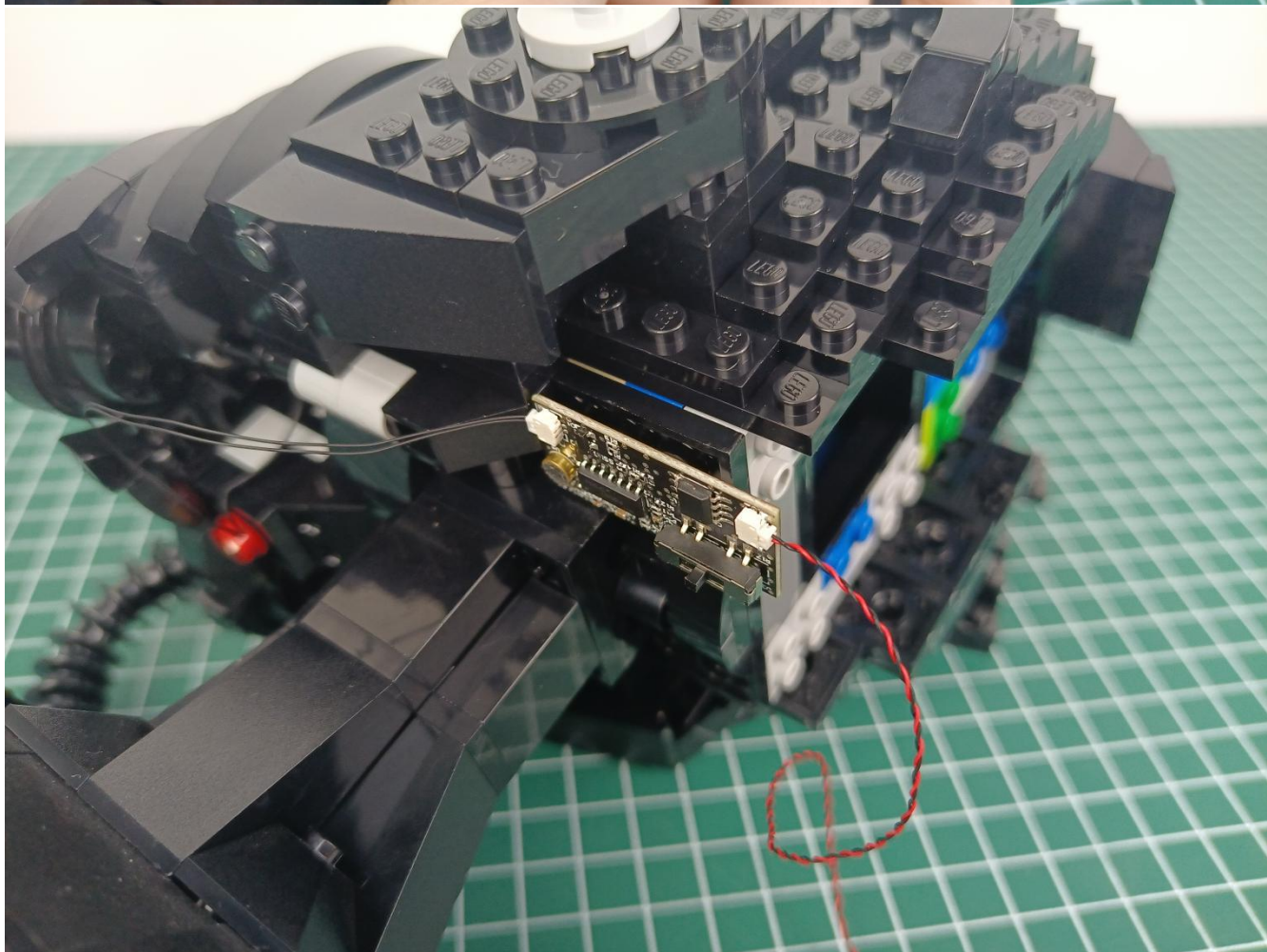
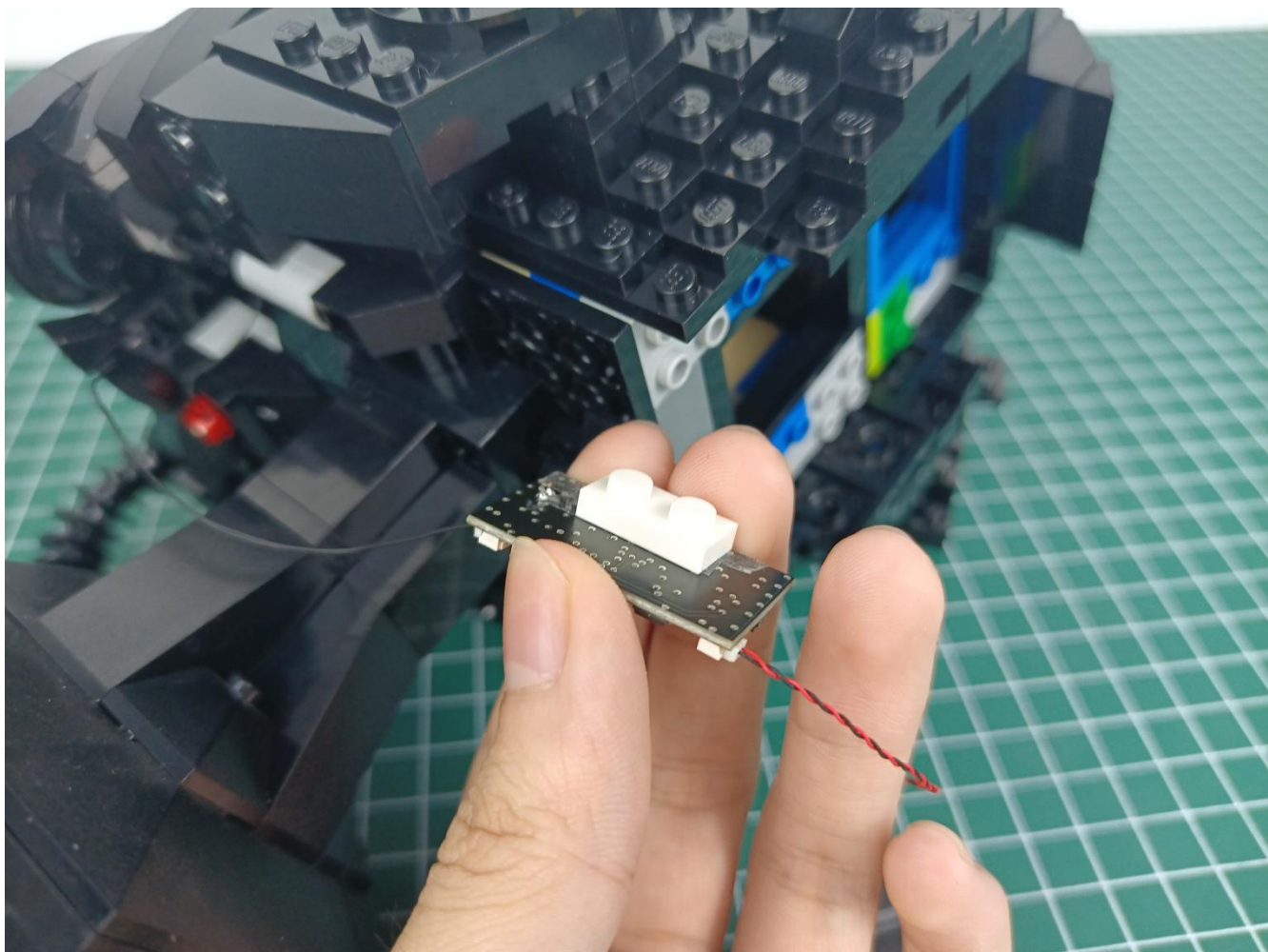

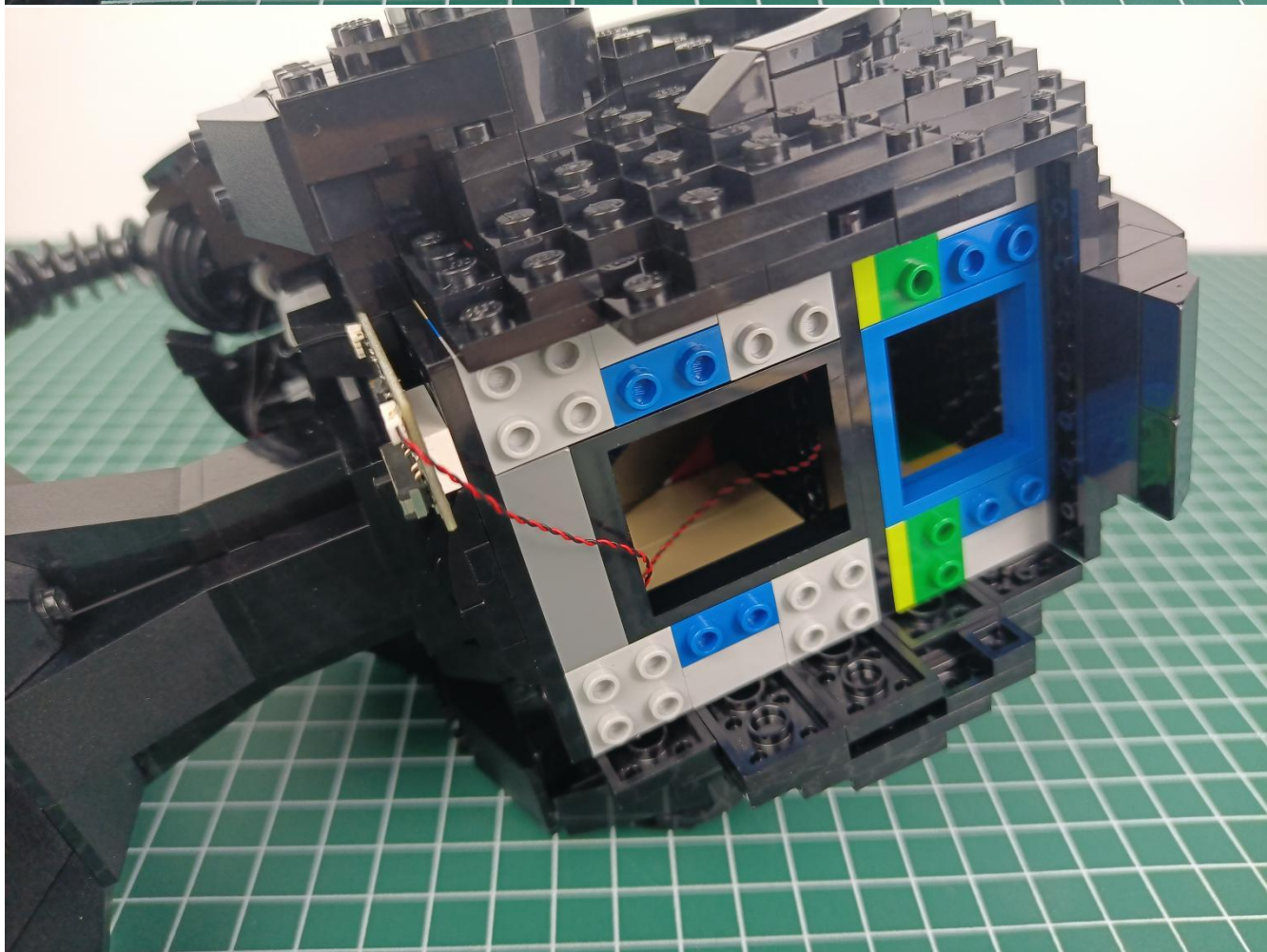
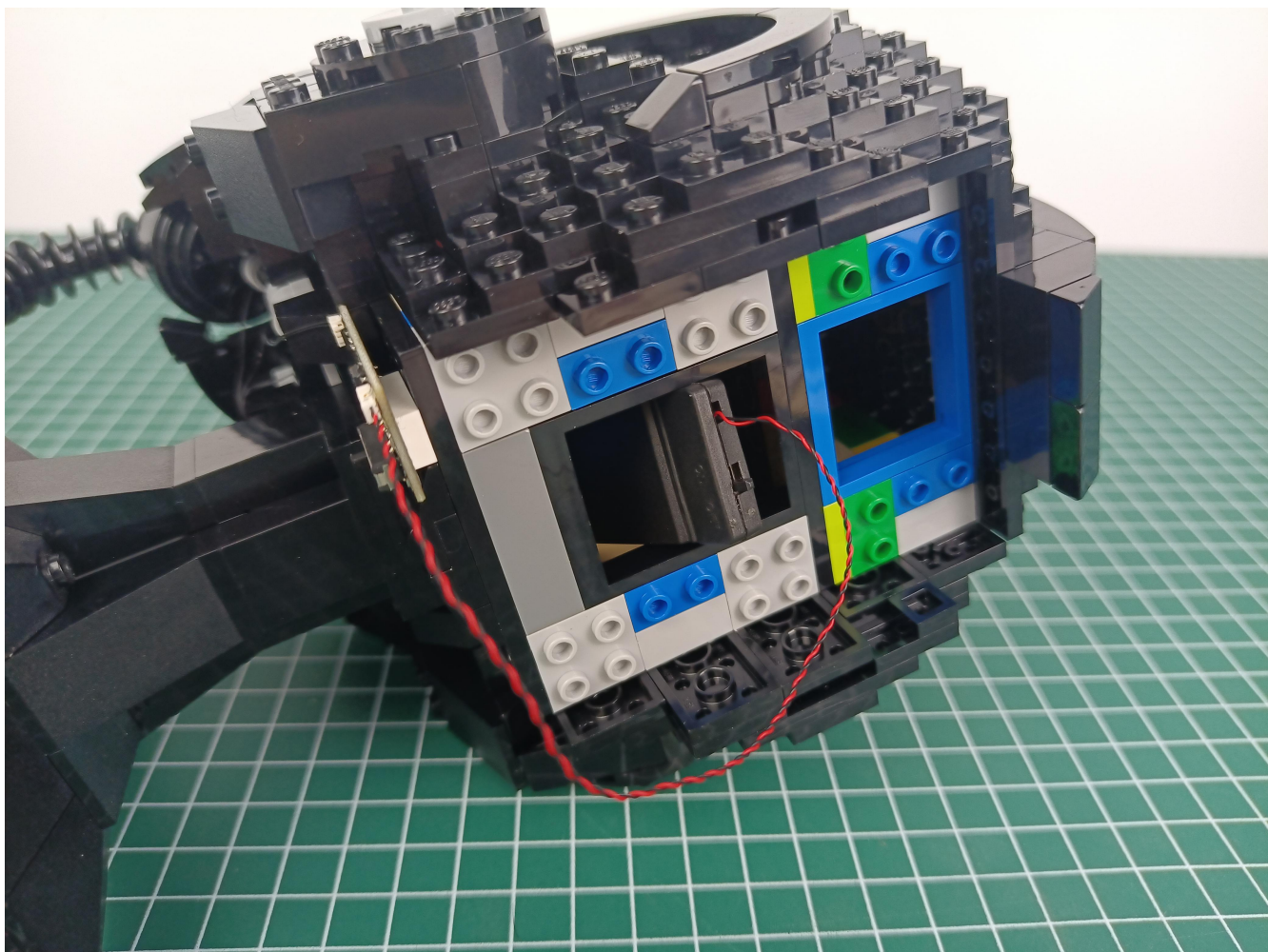

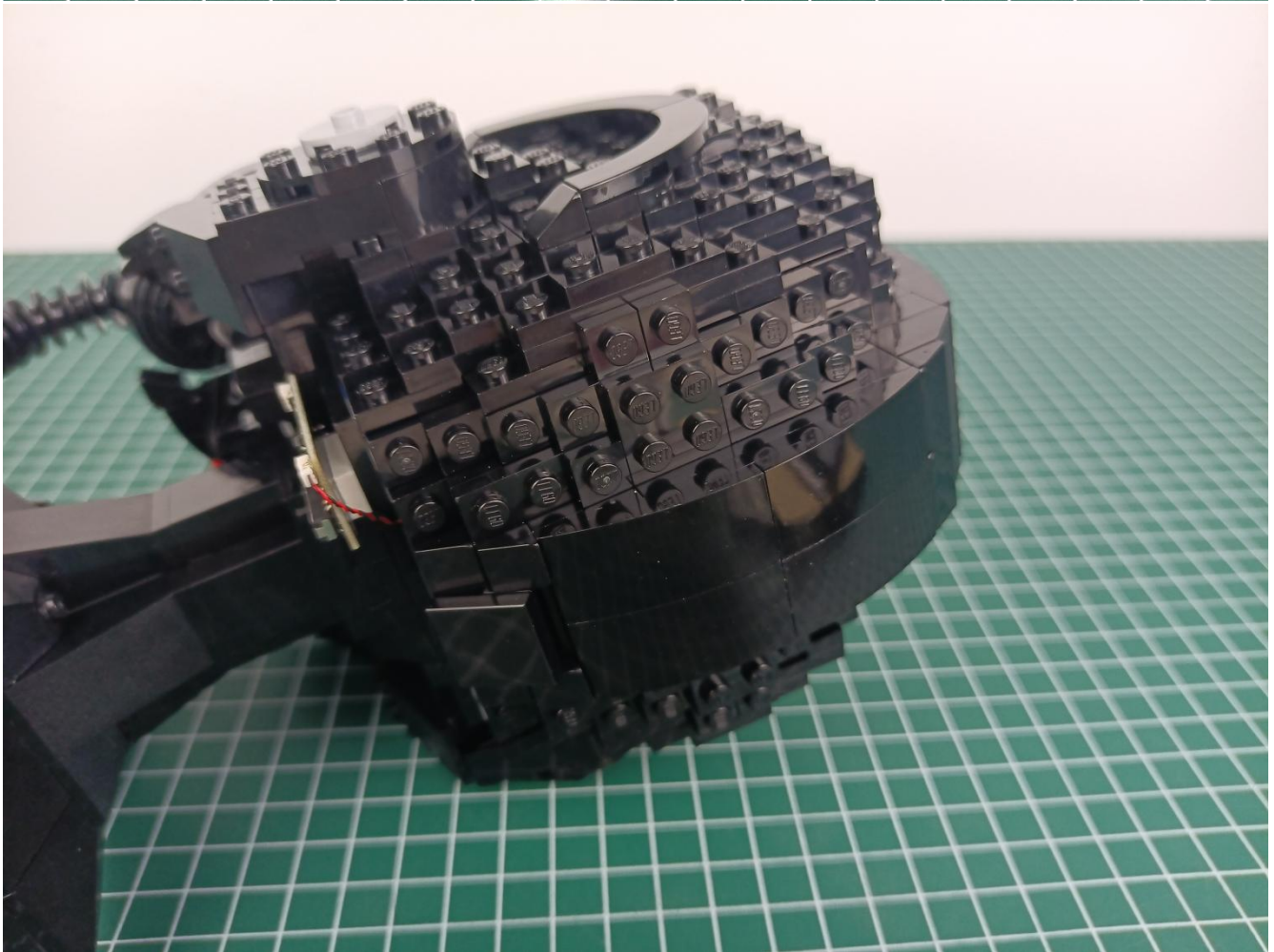

The installation is complete.



The above are ideas and instructions provided by our designers. Please move on:

- 1: Do you have any suggestions about the material and quality of our products?
- 2: Do you have any suggestions on the installation instructions and the degree of difficulty of the installation?
- 3: If you have better installation method and ideas, please contact us in time.